

Sistema  
**APi**

## Sistema API

Sistema de batente com RPT - 85 mm

### Características do sistema

Sistema de batente com rotura térmica de elevadas prestações térmicas e acústicas.

O sistema API possibilita a execução de 3 versões de caixilharia:

1. Linha recta;
2. Linha curva;
3. Linha oval.

O sistema API permite a aplicação de vidros duplos ou triplos de alto rendimento de modo a responder às exigências de isolamento térmico e acústico.

Com um óptimo isolamento térmico aliado à aplicação de um inovador produto designado por bagueete ThermoProfile, o Sistema API proporciona elevadas prestações de conforto e de economia energética.

### Perfis de alumínio

Os perfis de alumínio são extrudidos na liga de alumínio 6060 para arquitectura de acordo com norma NP EN 12020-02.

Rotura térmica obtida por inserção de varetas isolantes de poliamida tipo ómega de 39 mm reforçadas com 25% de fibra de vidro. Espessura média dos perfis de alumínio de 1.7 mm.

### Aros fixos

Secção dos aros fixos de 85 mm com tripla câmara;

Perfis com rotura térmica com varetas de poliamida tipo ómega de 39 mm;

Aros fixos com duplo esquadro de aperto rápido e esquadros de alinhamento para montagem a meia esquadria;

Travessas com dupla união para um aperto mais eficaz;

Aros fixos tradicionais para o mercado interno;

Aros fixos com clip exterior e aba de remate directa de 25 mm ou 45 mm para o mercado francês;

Aro fixo com clip exterior e interior para aplicação de remate de 30, 50 ou 80 mm para o mercado francês;

### Aros móveis

Secção dos aros móveis de 93 mm com tripla câmara;

Aros móveis com rotura térmica através de varetas de poliamidas tipo ómega de 39 mm;

Aros móveis com duplo esquadro de aperto rápido e esquadros de alinhamento para montagem a meia esquadria;

Perfil inversor com olhal para uma melhor aplicação do topo inversor.

### Dimensionamento e manobralidade

Dimensões mínimas - máximas de folha: 457 mm - 1700 mm (L); 457 mm - 3000 mm (H);

Peso máximo para janelas ou portas de sacada com oscilo-batente até 170 Kg;

Peso máximo para portas de entrada até 160 Kg/folha;

Possibilidades de abertura: fixo, batente interior 1 ou 2 folhas com ou sem oscilo-batente, batente exterior, basculante, projectante, hármónio e oscilo-paralela;

Solução de perfil para portas pedonais ou de sacada de abertura interior ou exterior segundo norma PMR (pessoas com mobilidade reduzida);

Enchimento para vidro duplo ou triplo desde 24 mm até 70 mm;

Estanquidade assegurada através de juntas duplas em EPDM (interior e central), com junta central termo-isolante de bi-material.

### Performances

Sistema certificado por laboratório notificado para Ensaio Tipo Inicial (ITT) de acordo com a norma de produto EN 14351-1 para efeitos de Marcação CE.

Categorias alcançadas na avaliação do sistema API:

1. Permeabilidade ao ar: Classe 4 (norma de ensaio EN 1026)
2. Estanquidade à água: Classe E1500 (norma de ensaio EN 1027)
3. Resistência ao vento: Classe C5 (norma de ensaio EN 12211)

Coefficiente de transmissão térmica de vão de 2 folhas com 1.20 m x 1.50 m com vidro  $U_g = 0.5 \text{ W/m}^2\text{K}$  com intercalar efeito "Warm Edge":

•  $U_w = 1.09 \text{ W/m}^2\text{K}$

Coefficiente de atenuação acústica de vão de 2 folhas:

•  $R_w (C ; C_{tr}) = 41 \text{ dB} (-2 ; -5)$

Zonas de aplicação segundo RCCTE (em função do valor  $U_g$ ) : I1, I2, I3, V1, V2, V3

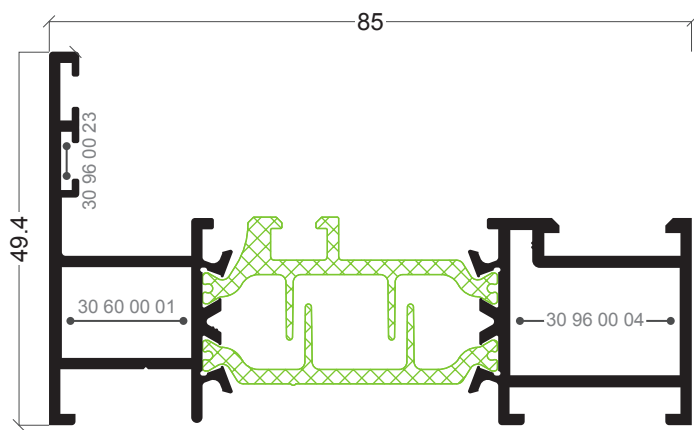

**API-03**  
Aro fixo

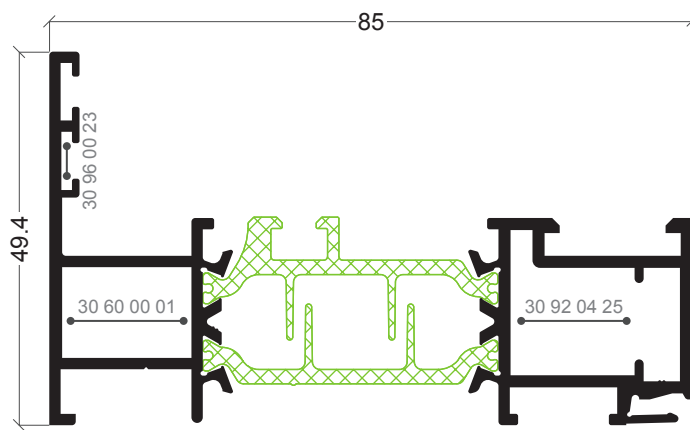

**API-91**  
Aro fixo

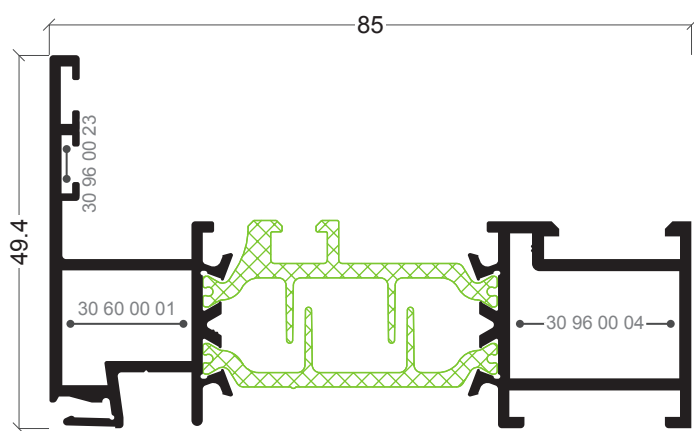

**API-76**  
Aro fixo

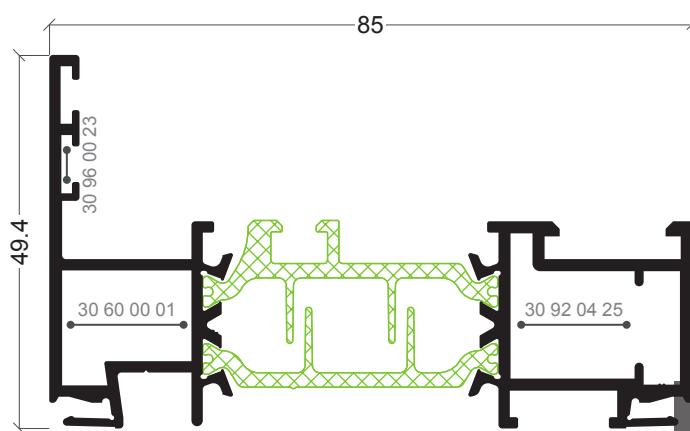

**API-80**  
Aro fixo

155

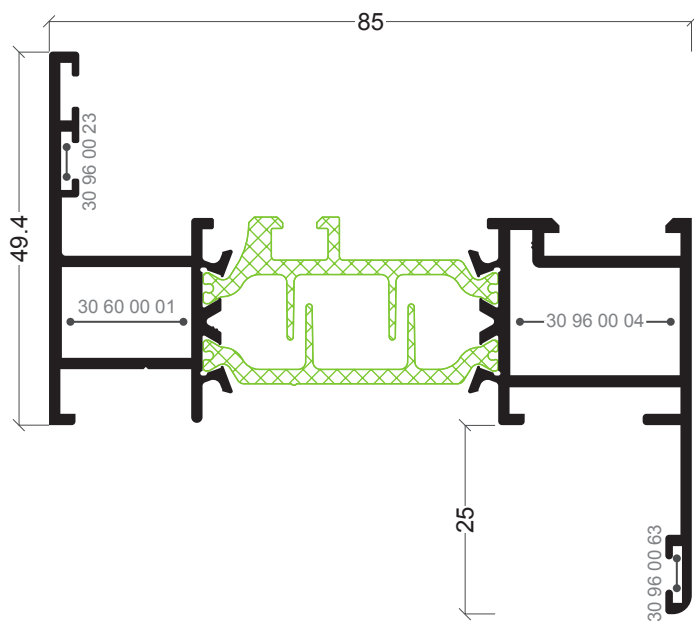

**API-35**  
Aro fixo com remate 25 mm

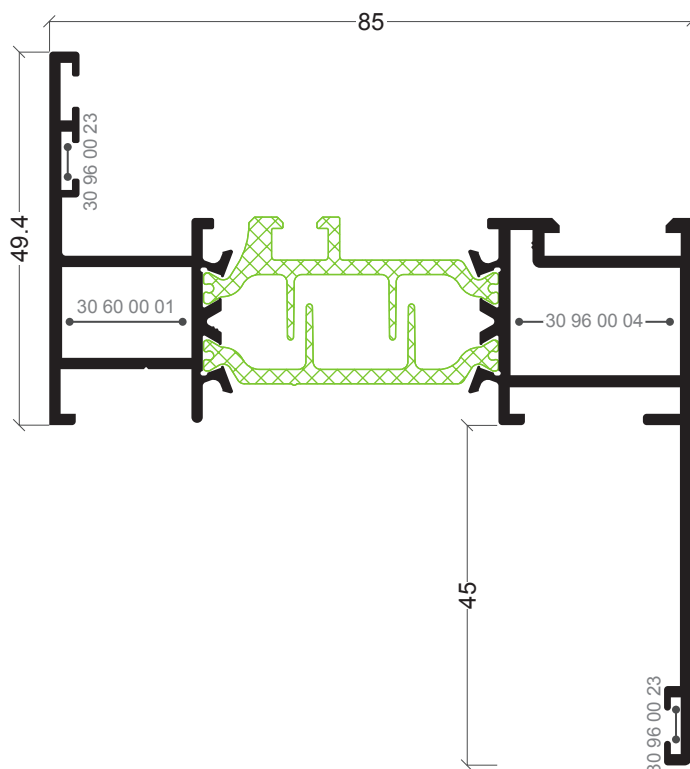

**API-33**  
Aro fixo com remate 45 mm

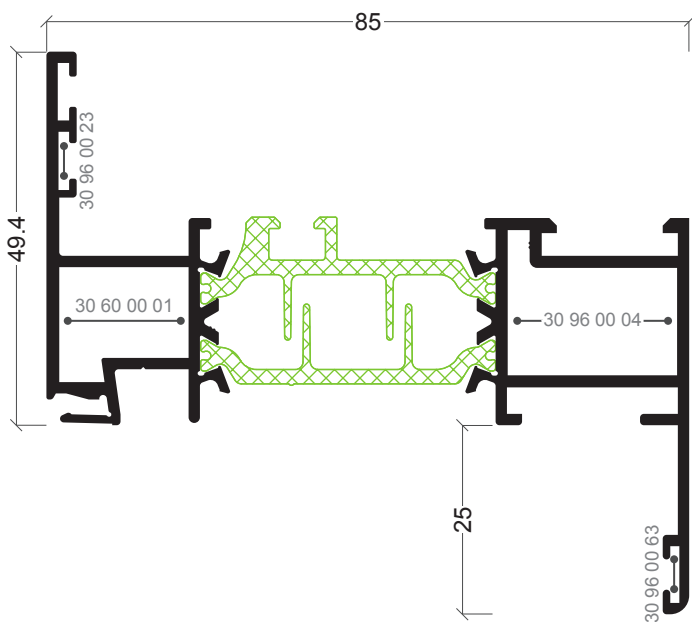

**APi-74**  
Aro fixo com remate 25 mm

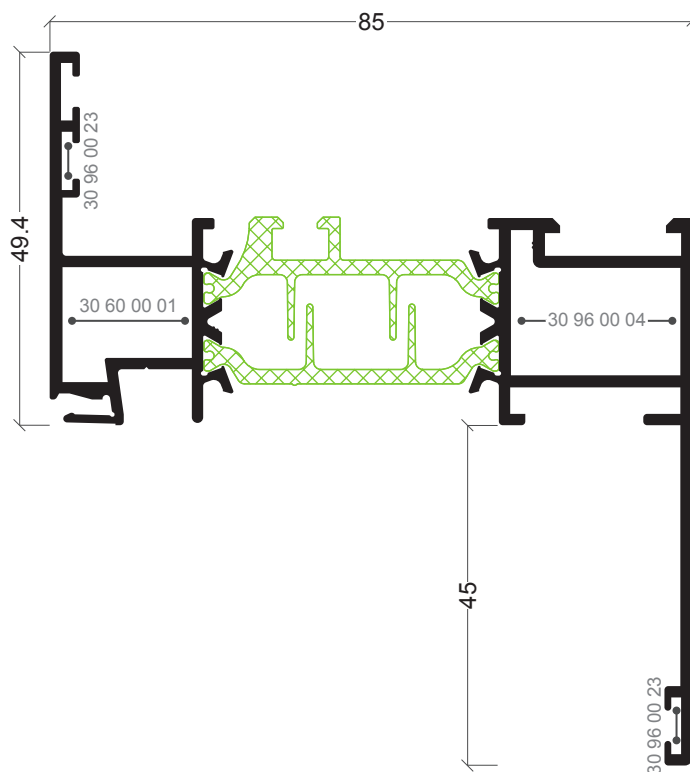

**APi-75**  
Aro fixo com remate 45 mm

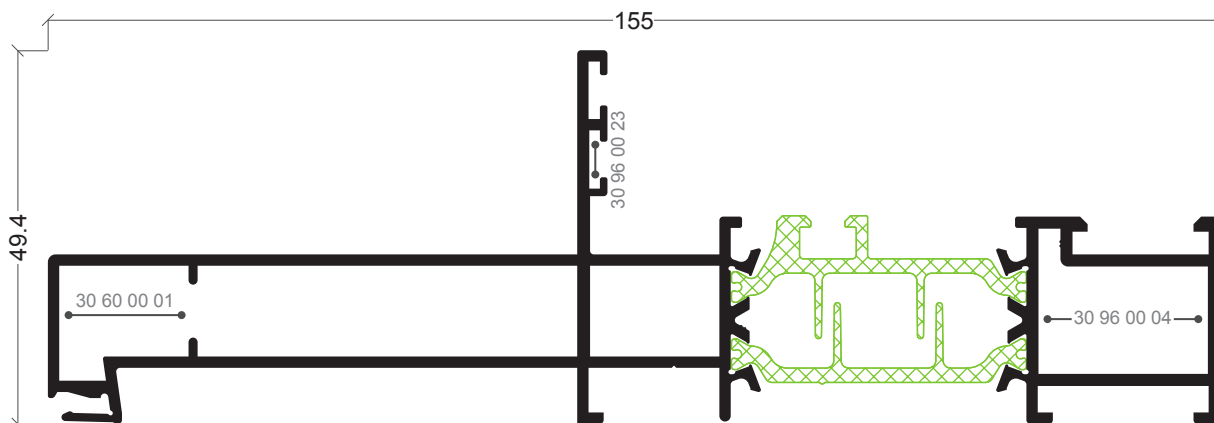

**APi-89**  
Aro fixo

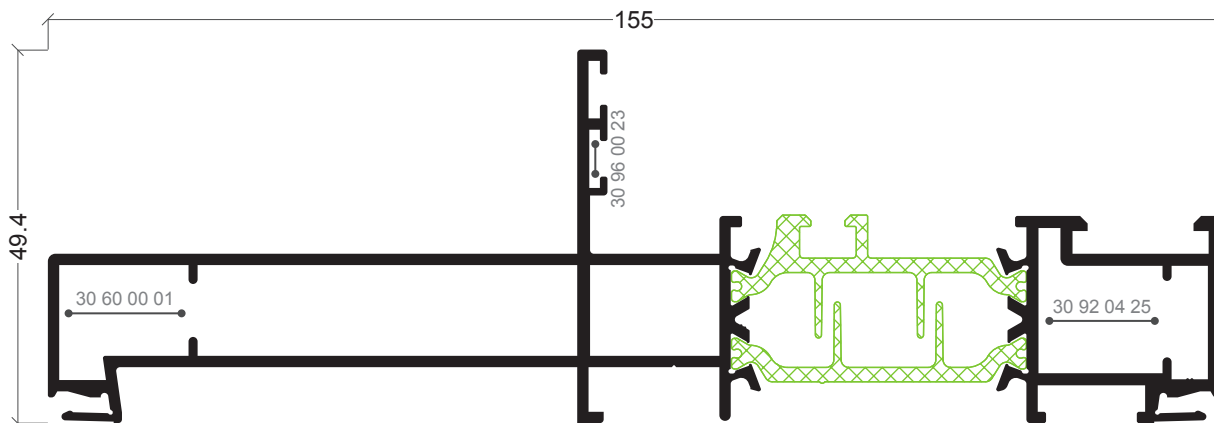

**APi-88**  
Aro fixo

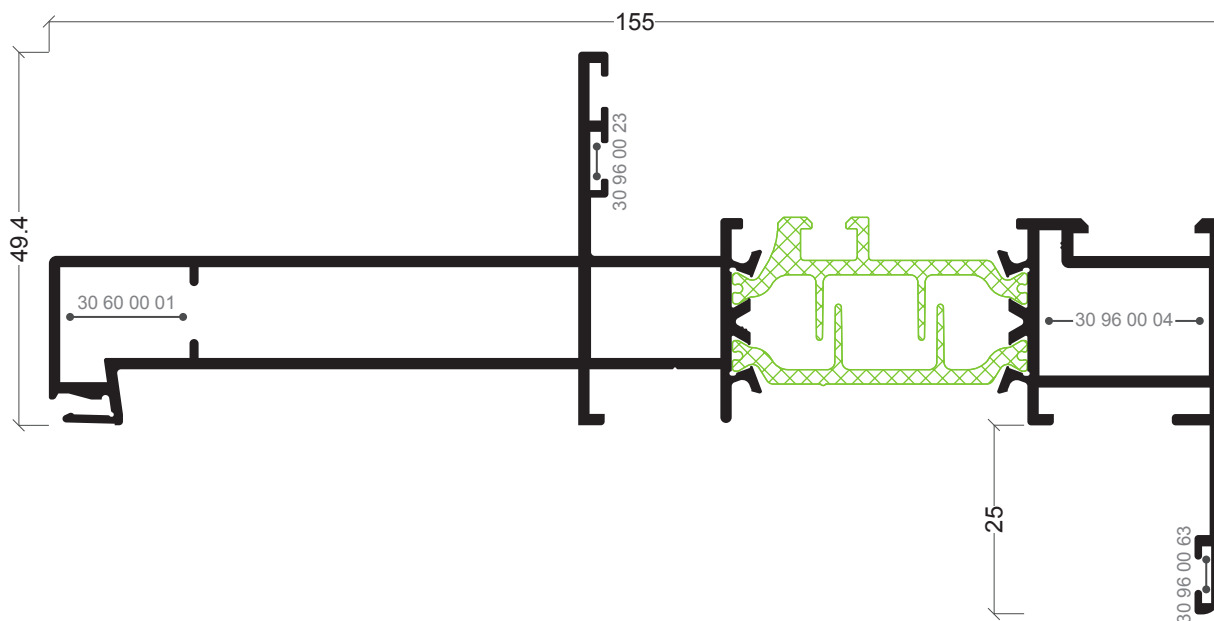

**APi-86**  
Aro fixo com remate 25 mm

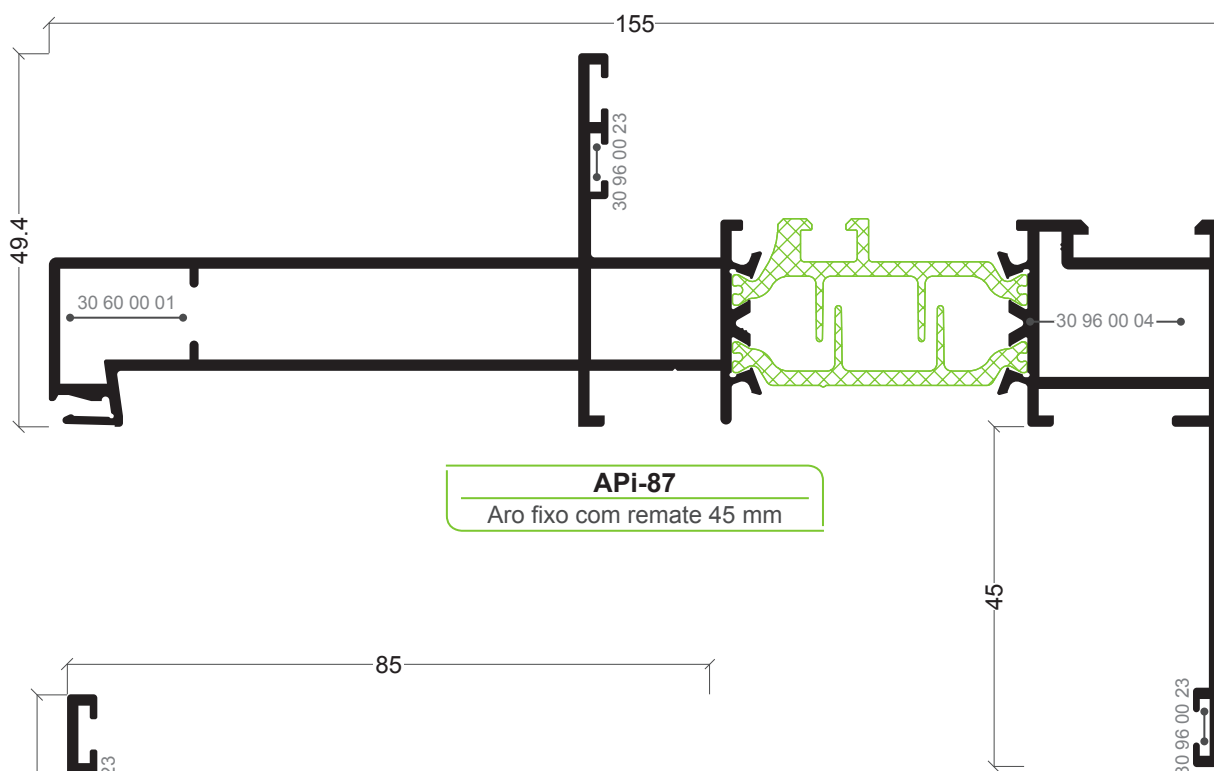

**APi-87**  
Aro fixo com remate 45 mm

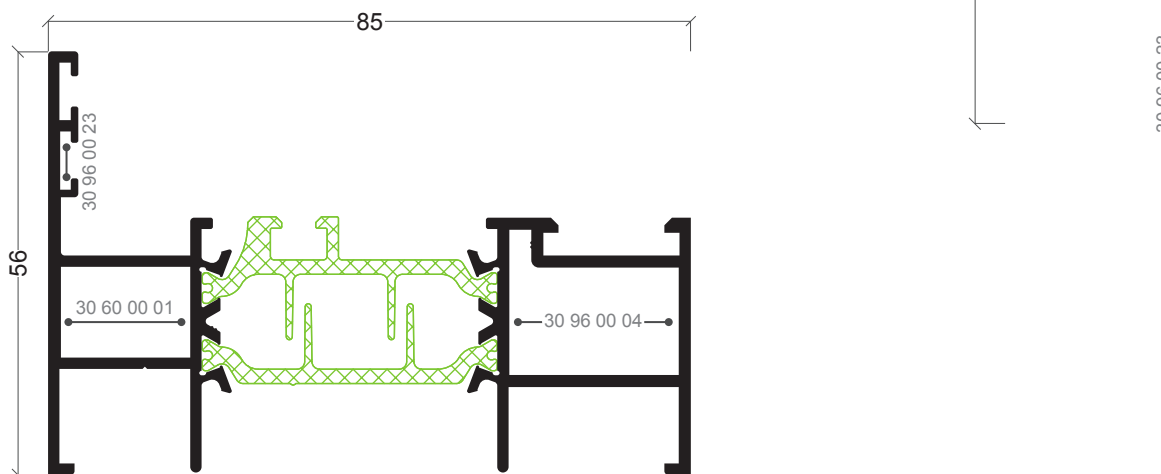

**APi-81**  
Aro fixo

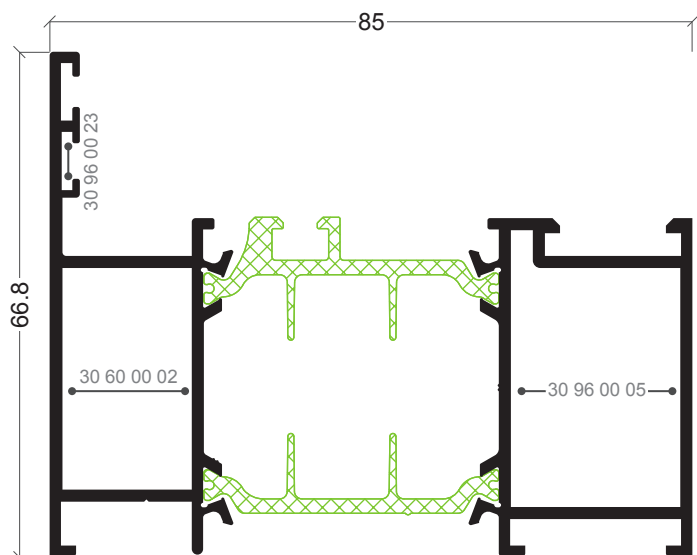

**API-08**  
Aro fixo

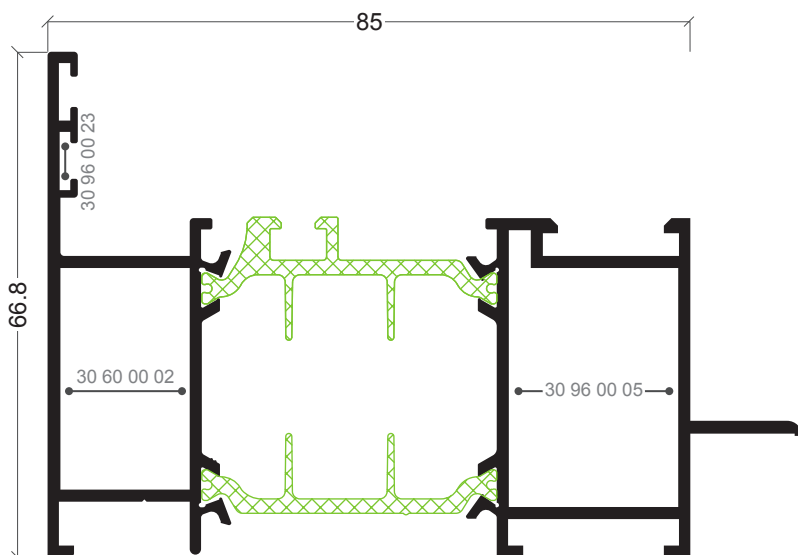

**API-68**  
Aro fixo

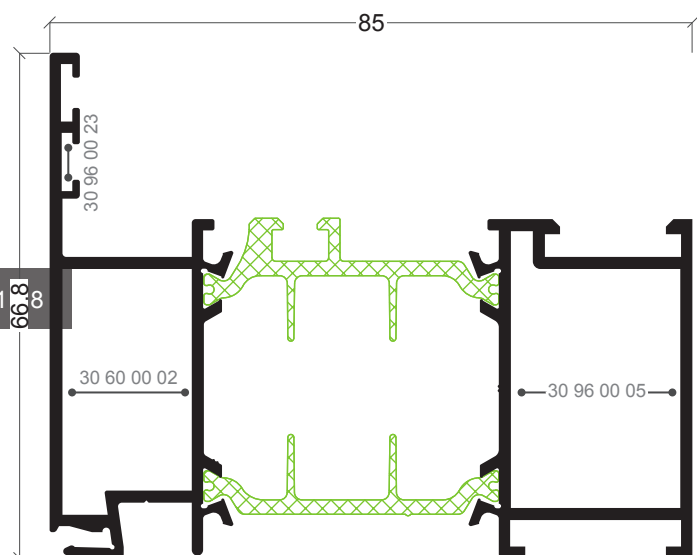

**API-92**  
Aro fixo

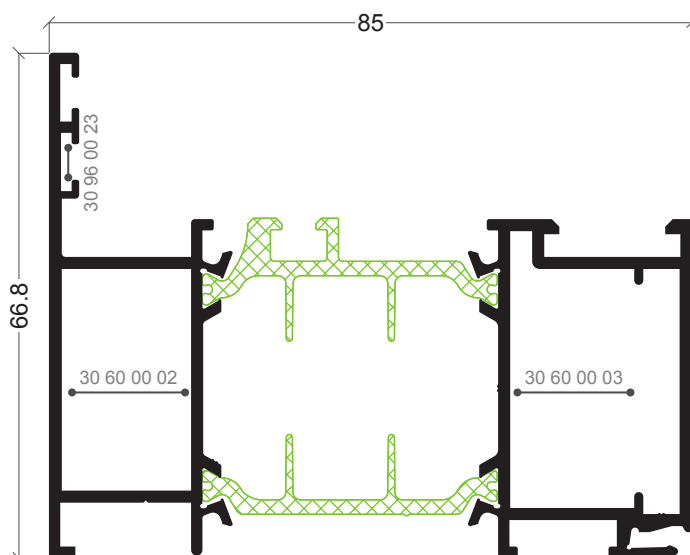

**API-93**  
Aro fixo

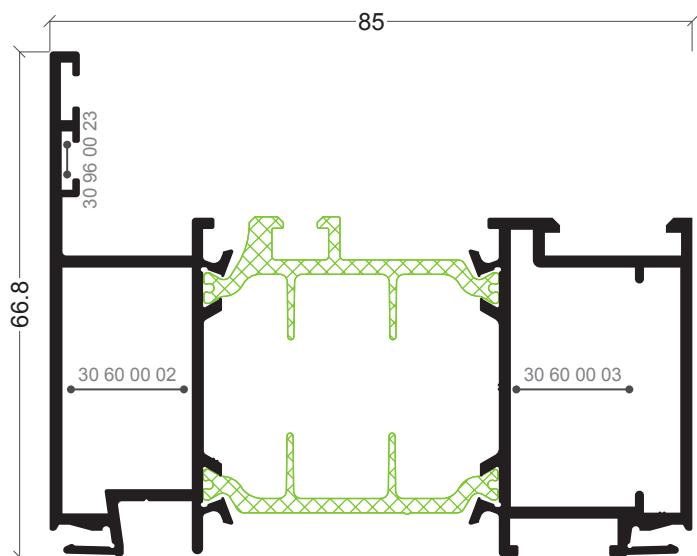

**API-94**  
Aro fixo

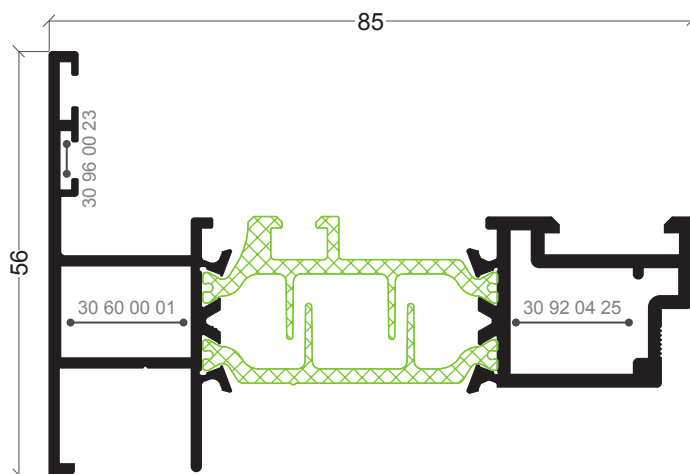

**API-73**  
Inversor de sentido de abertura

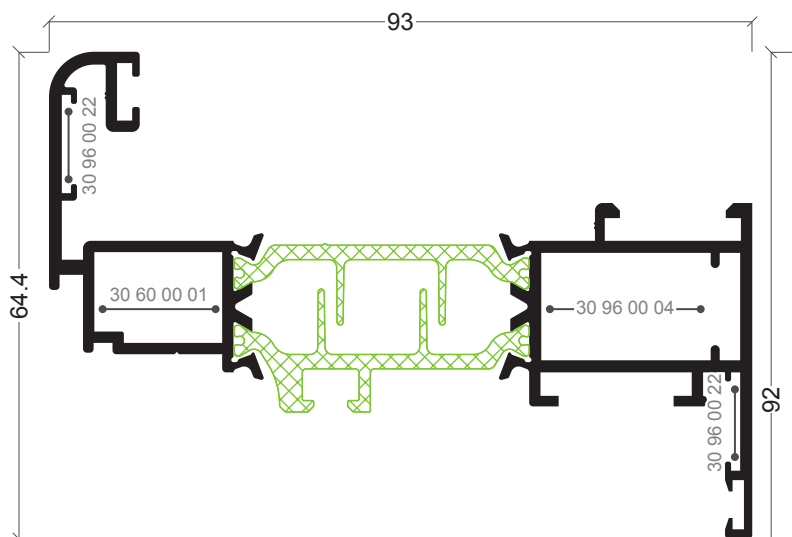

**APi-05**  
Aro móvil

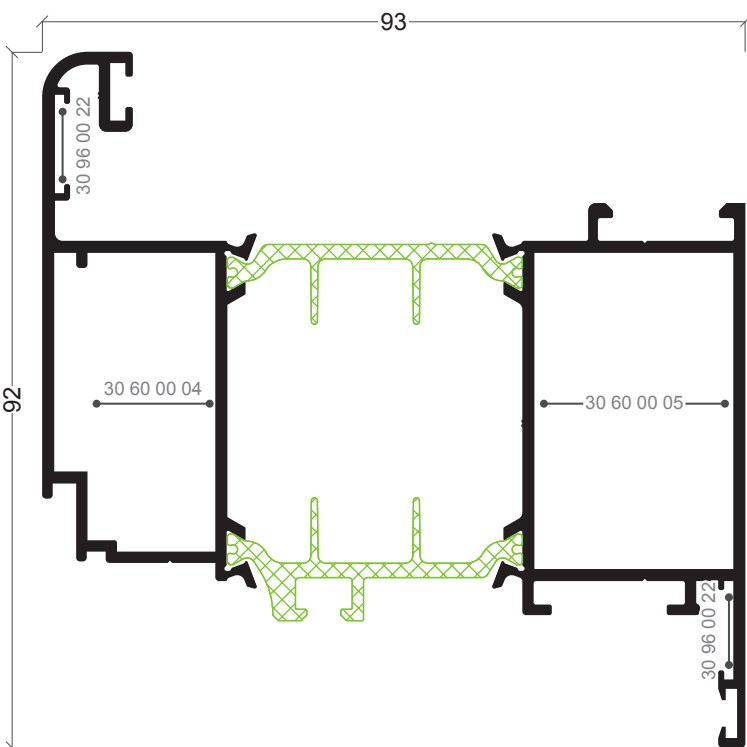

**APi-10**  
Aro móvil

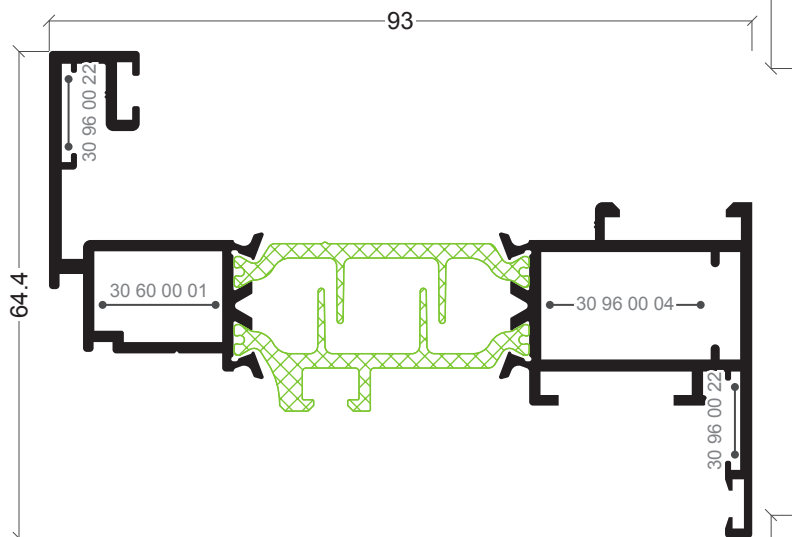

**APi-61**  
Aro móvil

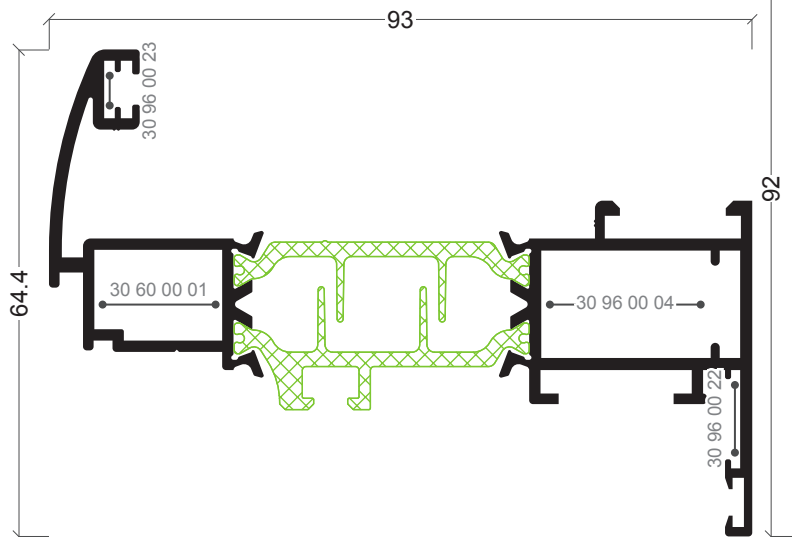

**APi-83**  
Aro móvil

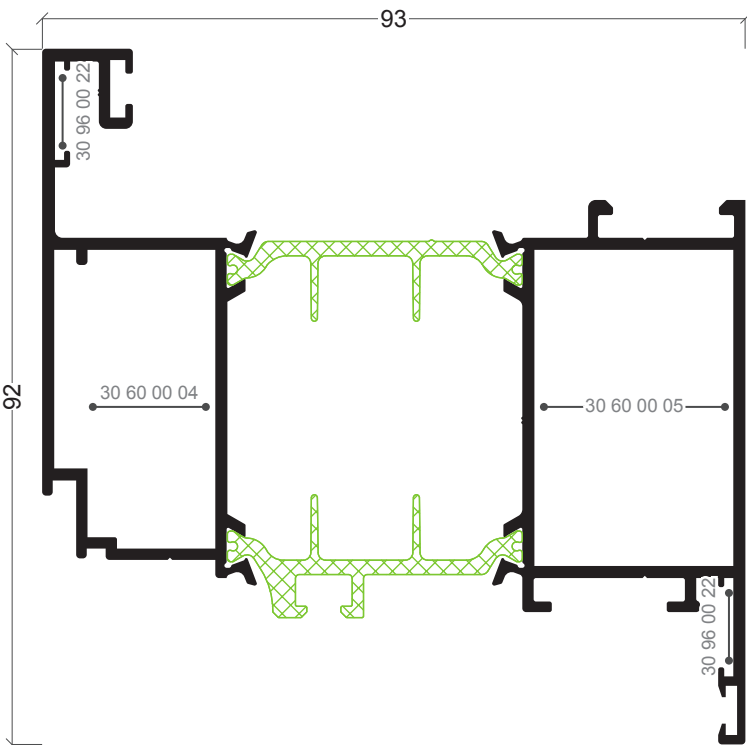

**APi-36**  
Aro móvil

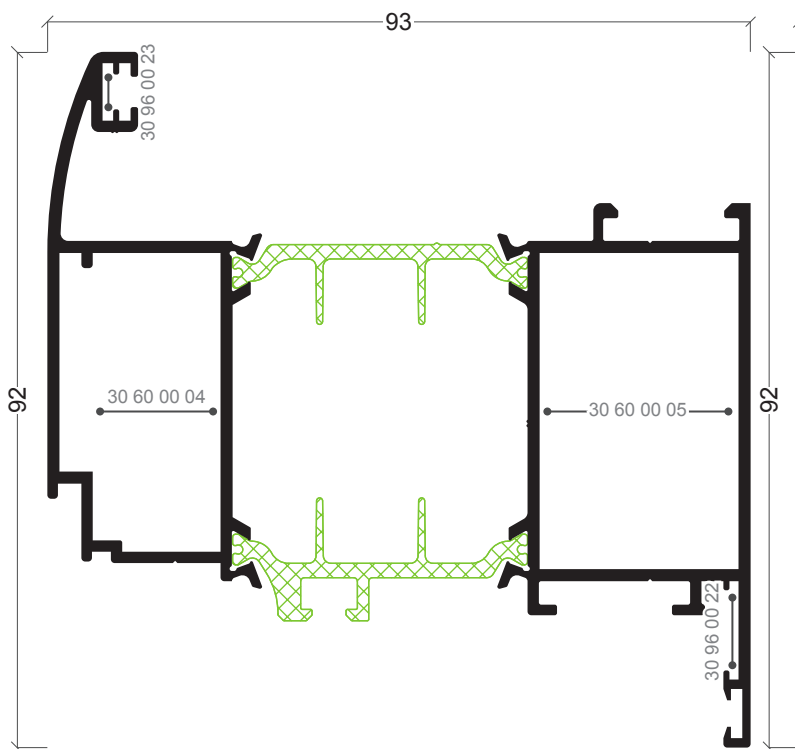

**APi-84**  
Aro móvel

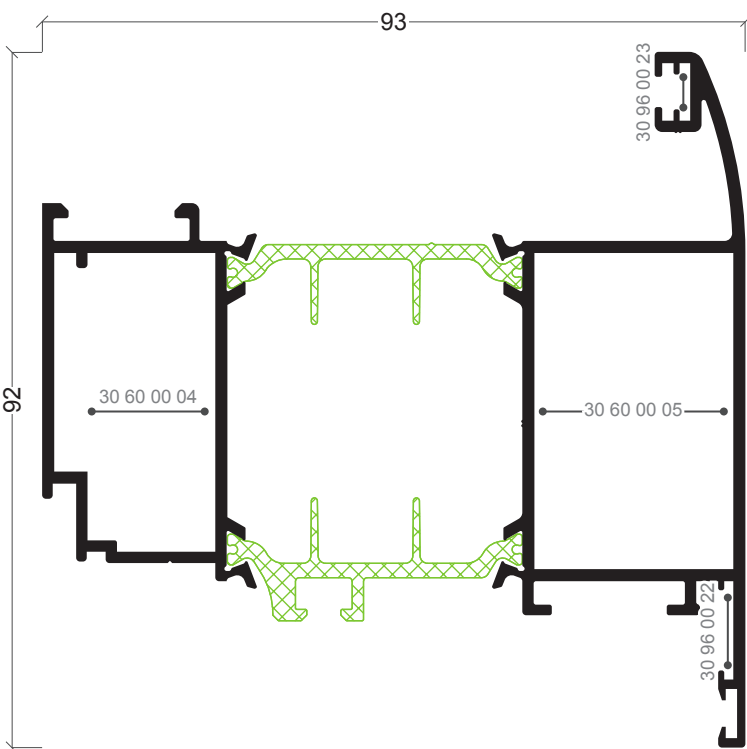

**APi-85**  
Aro móvel

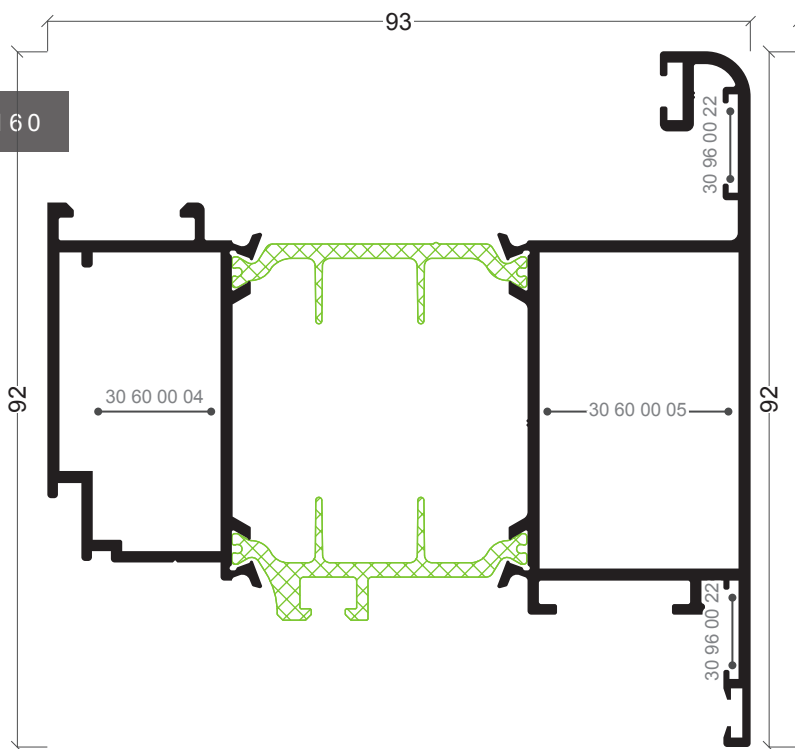

**APi-90**  
Aro móvel

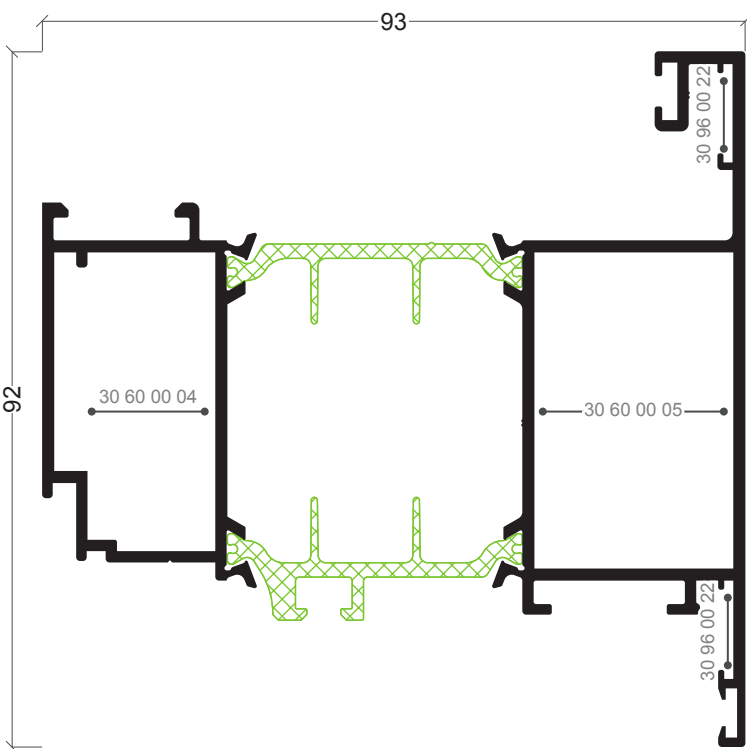

**APi-72**  
Aro móvel

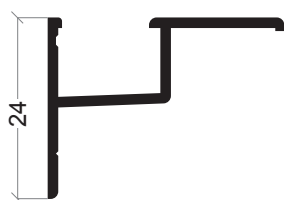

**Y-20**  
Recolha de águas condensação

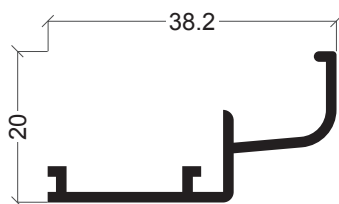

**ARi-32**  
Complemento condensação

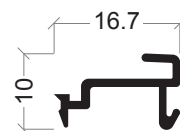

**AX-33**  
Mola Bite



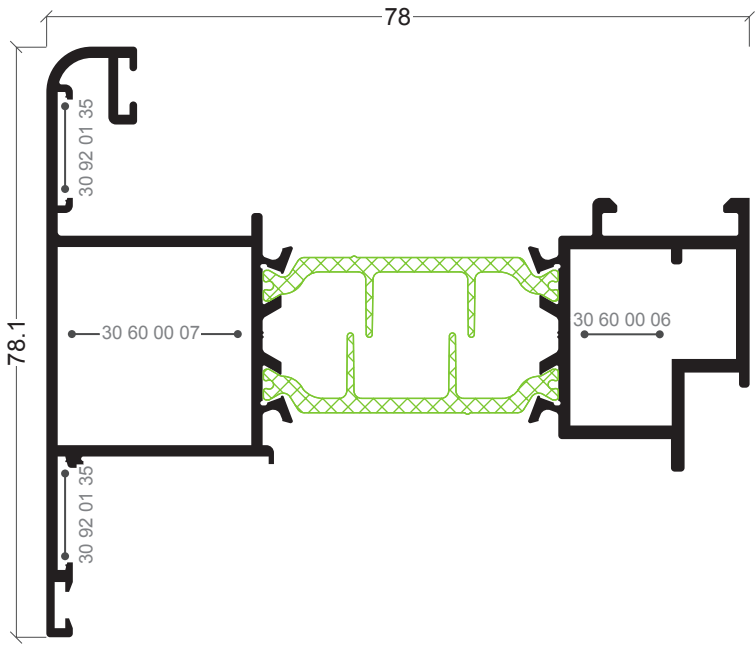

**APi-07**  
Aro móvel projectante

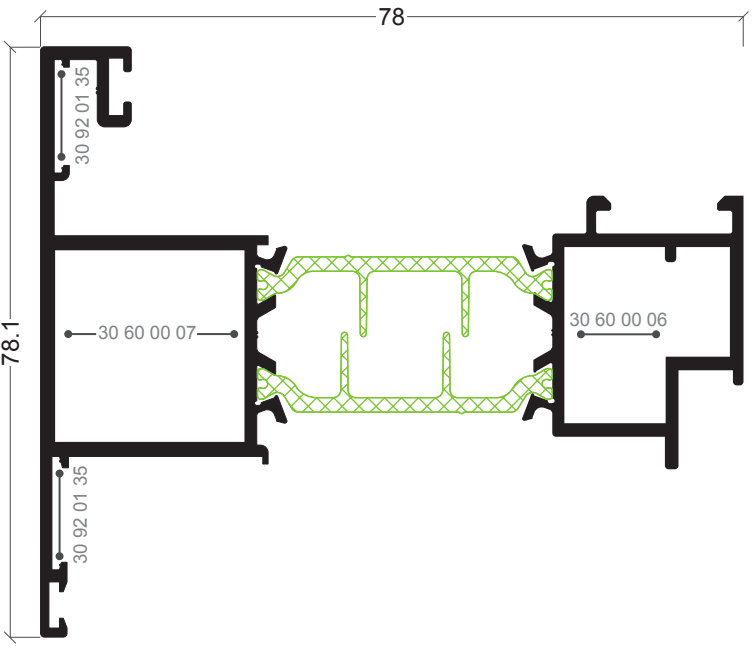

**APi-95**  
Aro móvel projectante

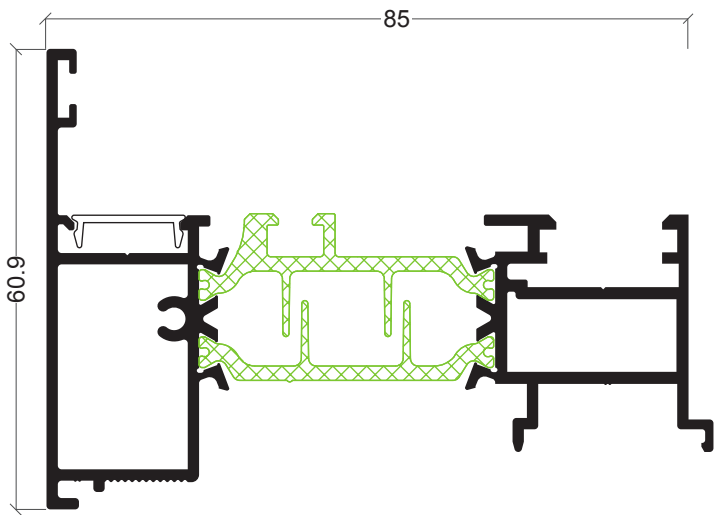

**APi-04**  
Inversor

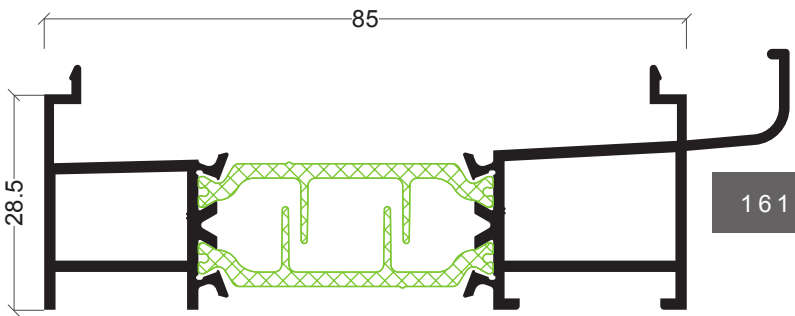

**APi-71**  
Soleira condensação

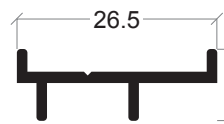

**AXi-32**  
Complemento projectante



**AXi-31**  
Guia projectante

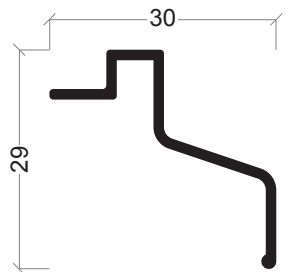

**AXi-45**  
Pingadeira projectante



**KL-04**  
Tampa



**AX-19**  
Vareta

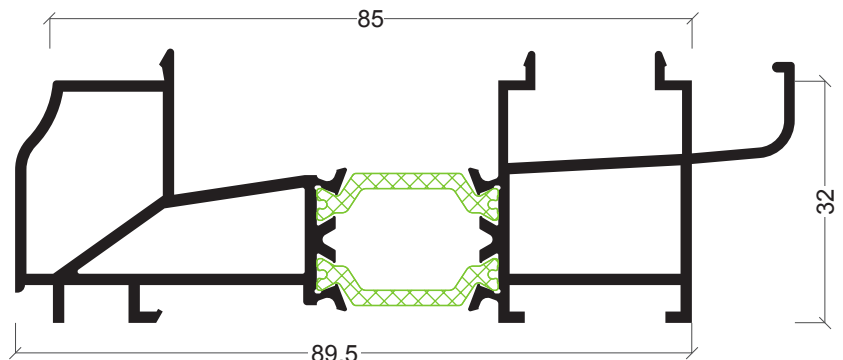

**ARi-56**  
Soleira condensação

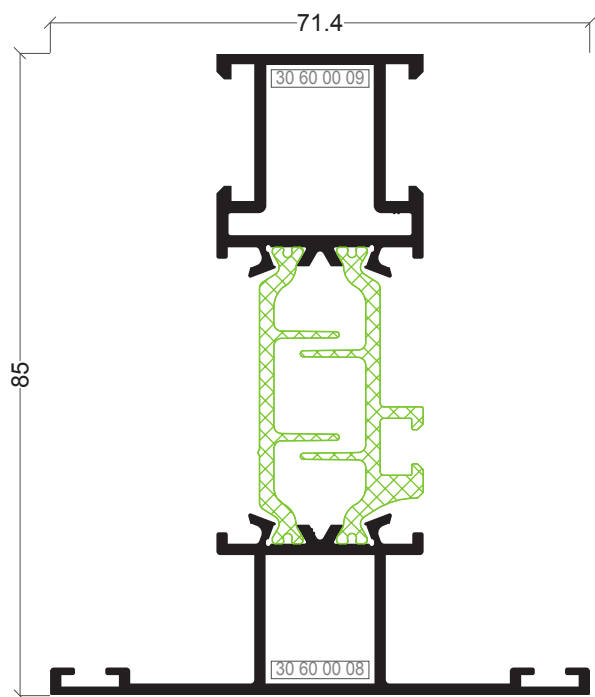

**API-01**  
Travessa

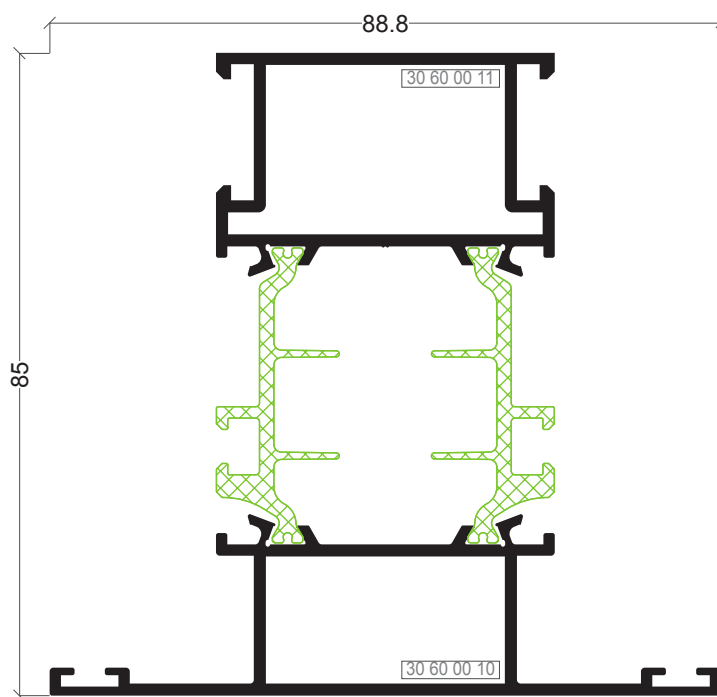

**API-06**  
Travessa

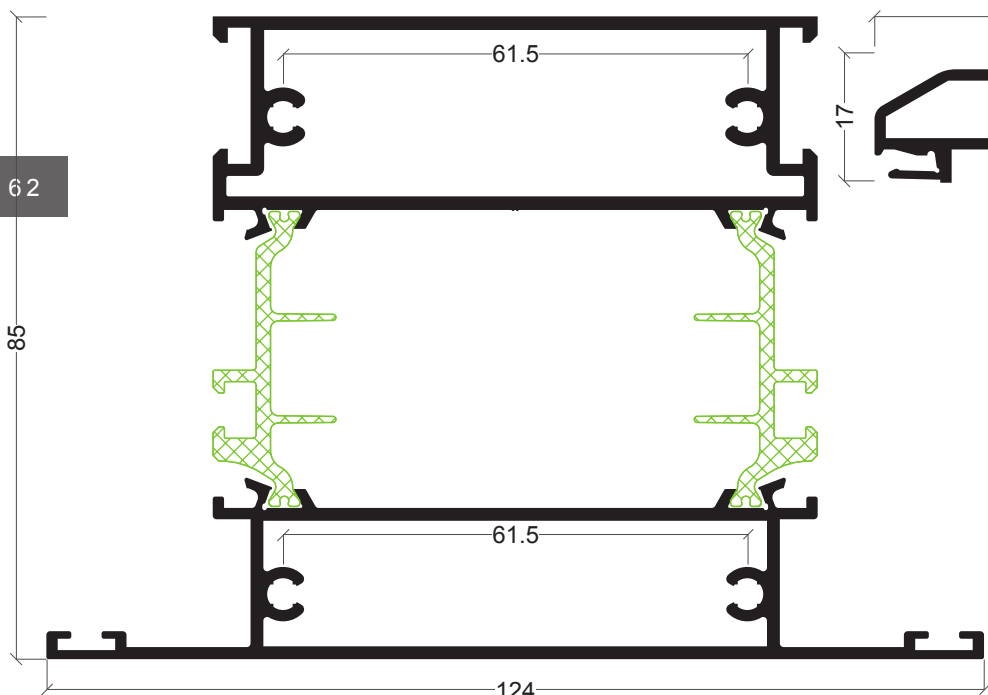

**API-12**  
Travessa

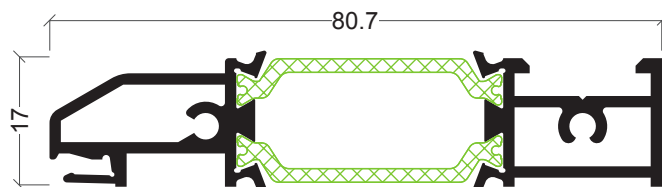

**API-63**  
Remate inferior porta

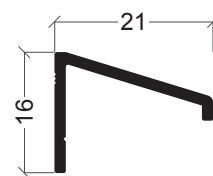

**A1-46**  
Pingadeira janela

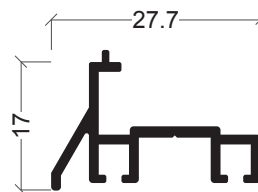

**AJi-62**  
Pingadeira inferior porta sacada

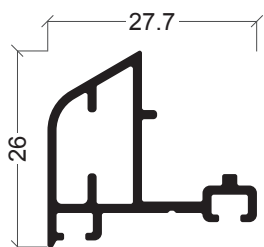

**AZ-79**  
Pingadeira inferior de porta

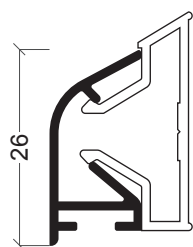

**AZ-60**  
Pingadeira

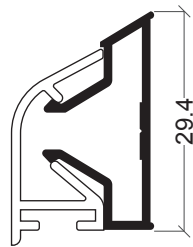

**AZ-61**  
Clip pingadeira

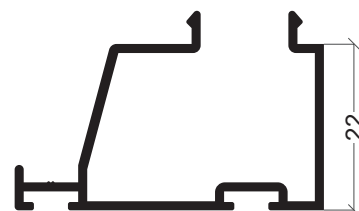

**AJi-82**  
Bite remate

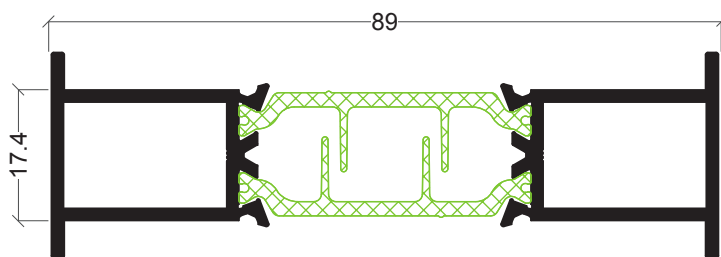

**API-21**  
União de aros

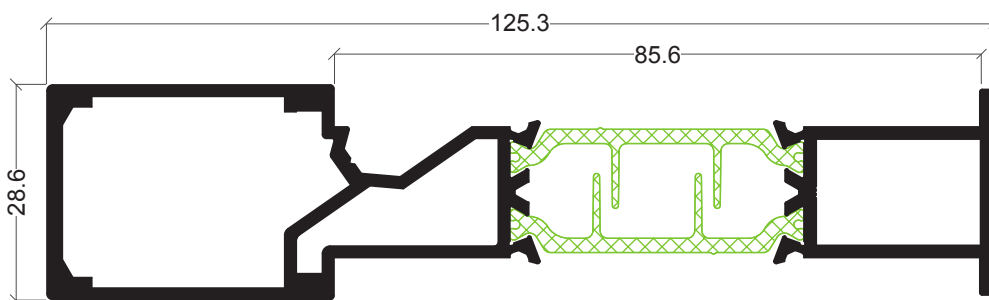

**API-65**  
União de aros

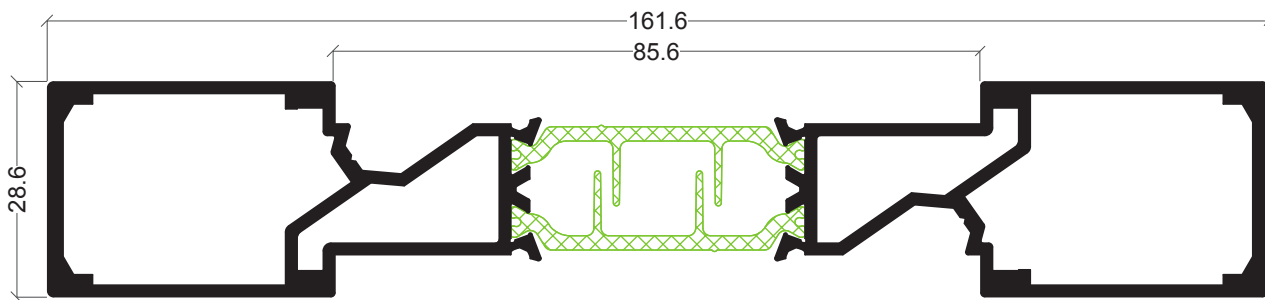

**API-67**  
União de aros

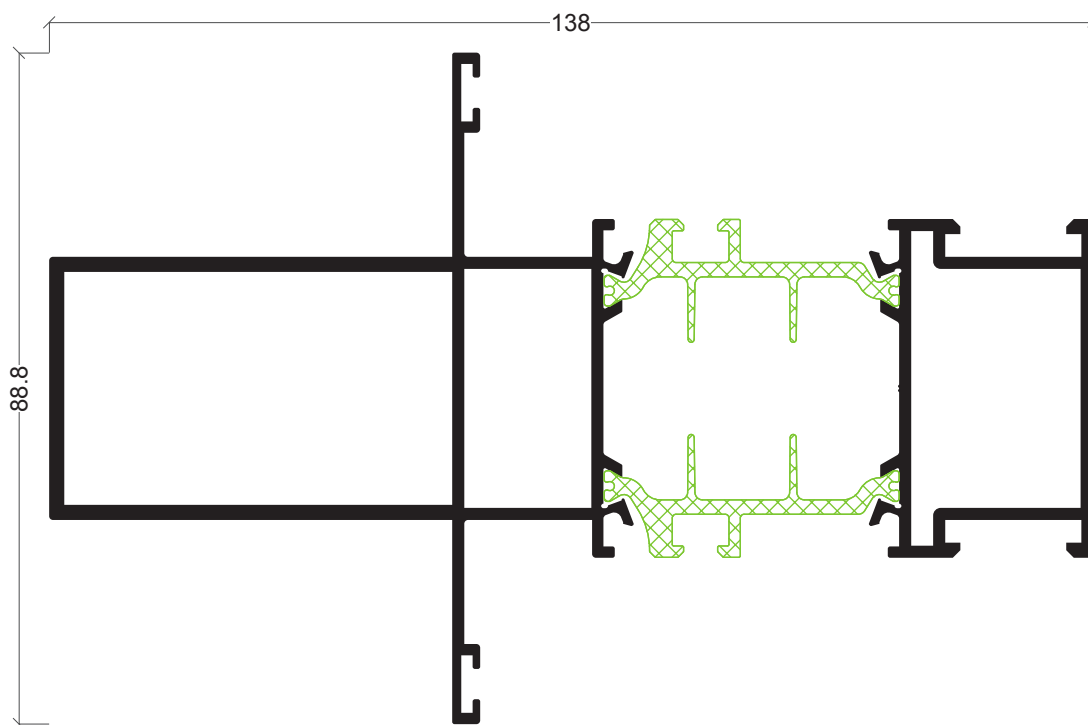

**API-79**  
Montante recto

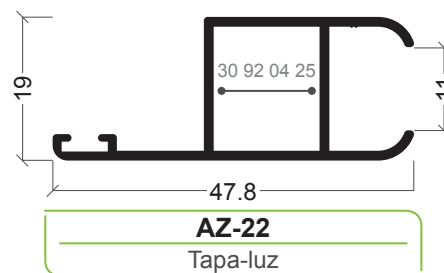
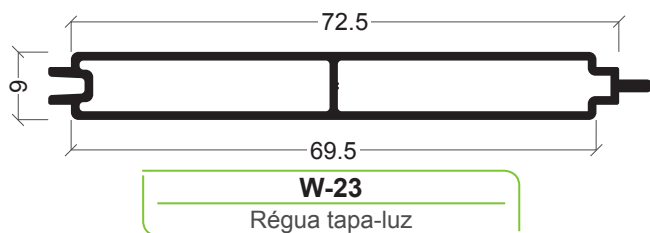
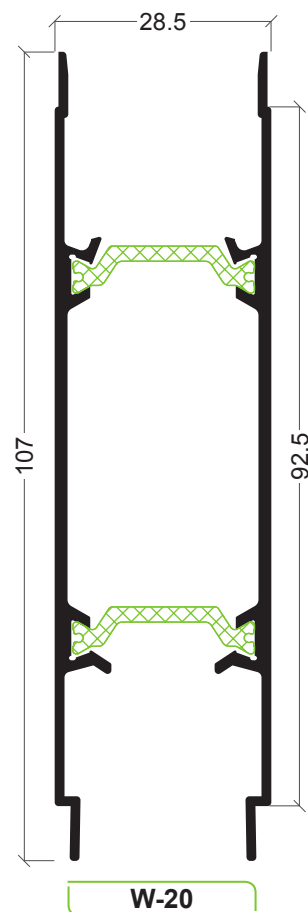
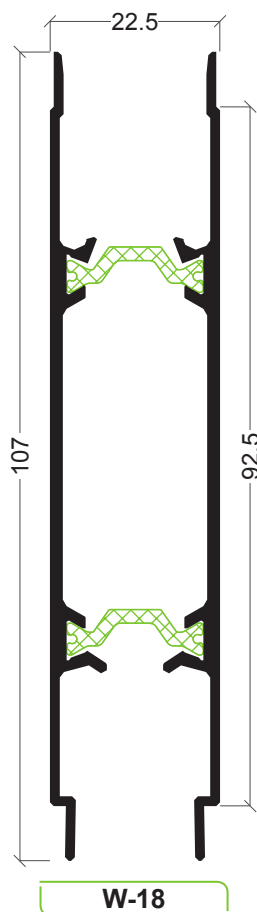
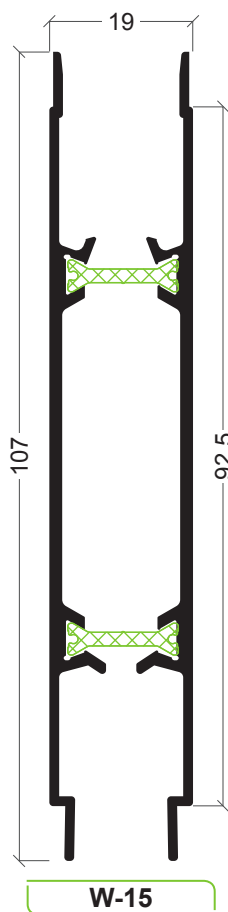

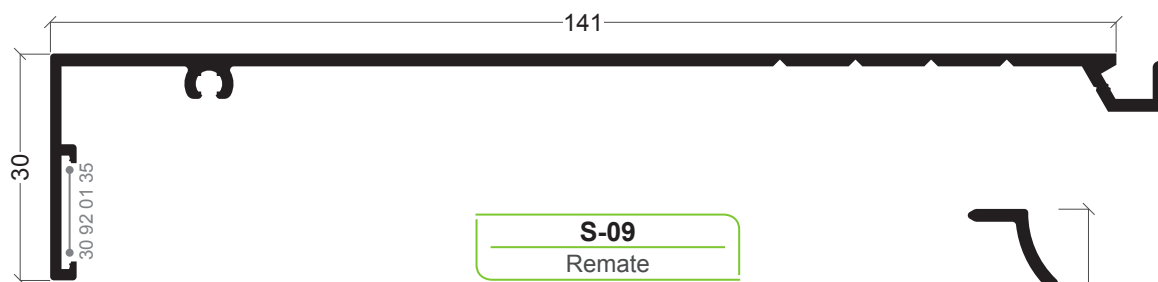

**S-09**  
Remate

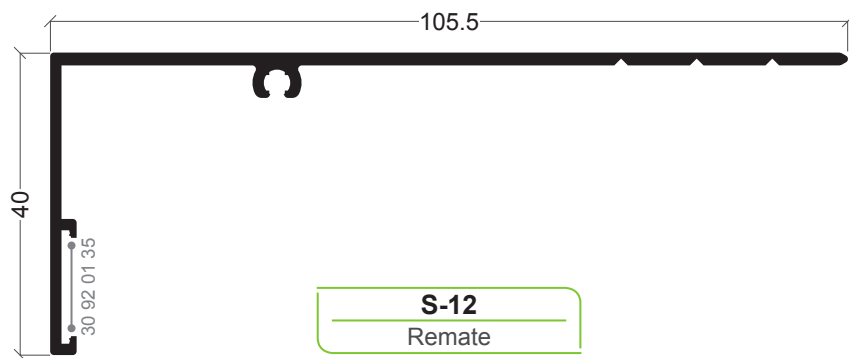

**S-12**  
Remate

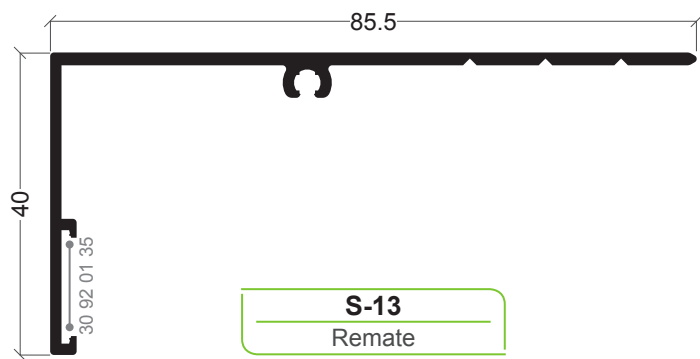

**S-13**  
Remate

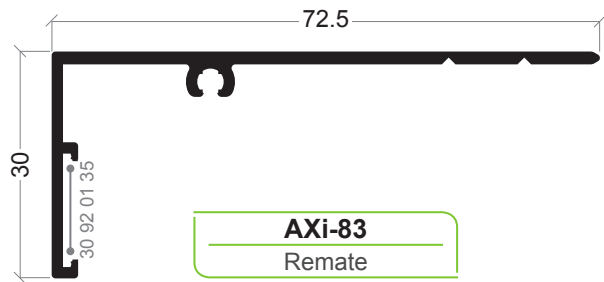

**AXi-83**  
Remate

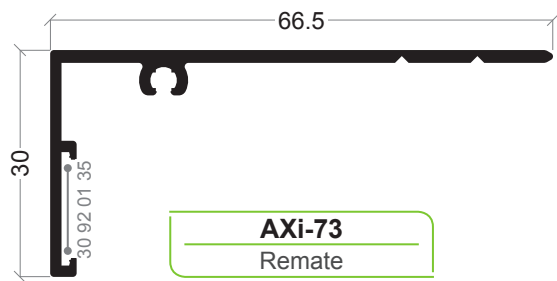

**AXi-73**  
Remate

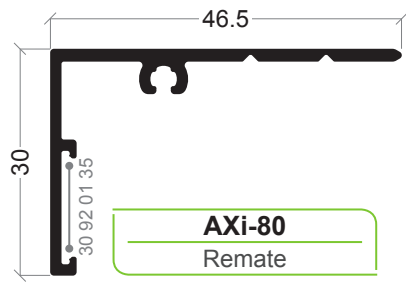

**AXi-80**  
Remate

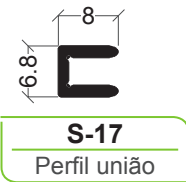

**S-17**  
Perfil união



**S-18**  
Remate



**S-14**  
Remate



**AXi-88**  
Complemento remate



**AXi-91**  
Complemento remate

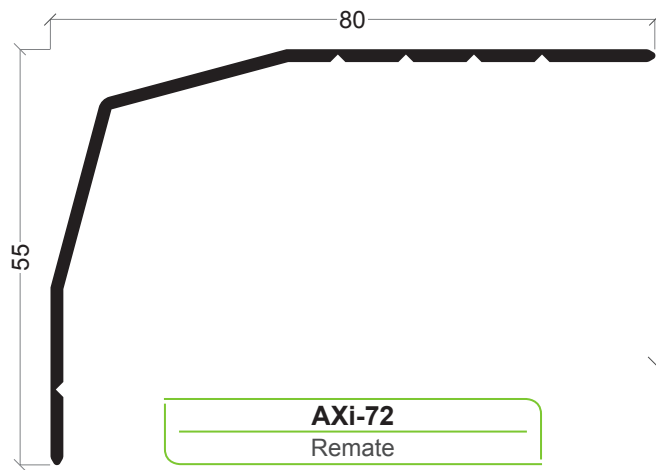

**AXi-72**  
Remate

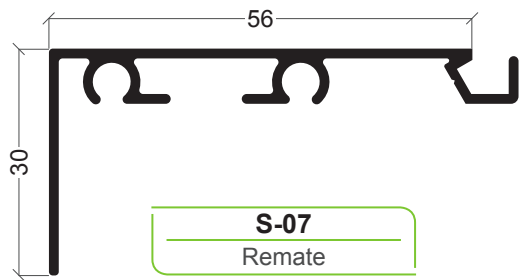

**S-07**  
Remate

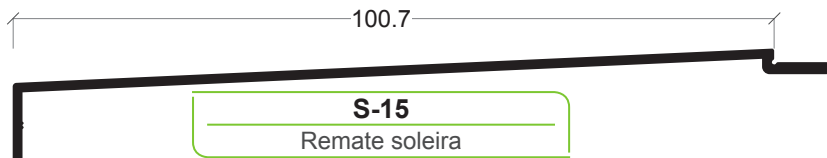

**S-15**  
Remate soleira

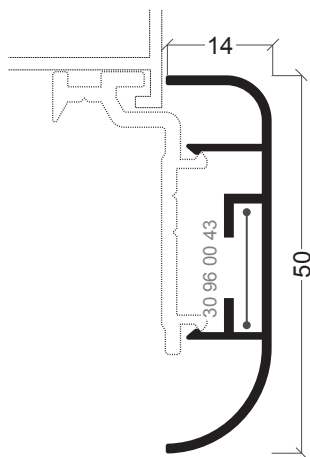

**ARi-27**  
Tapa juntas

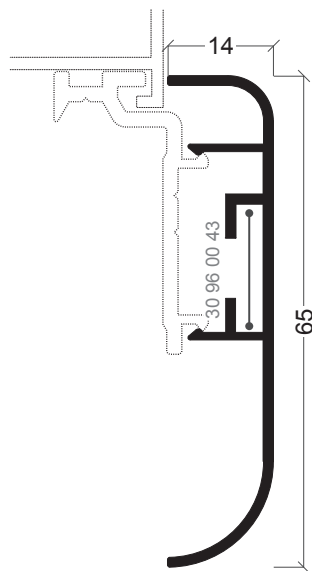

**ARi-34**  
Tapa juntas

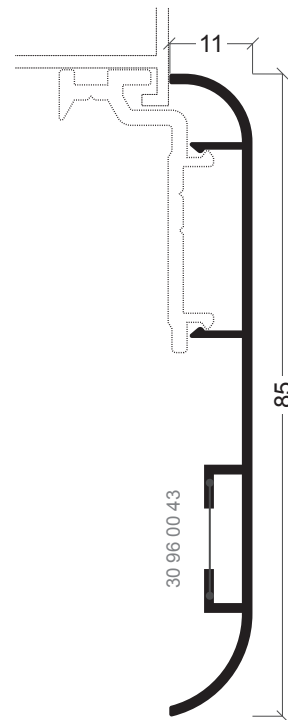

**ARi-28**  
Tapa juntas

166

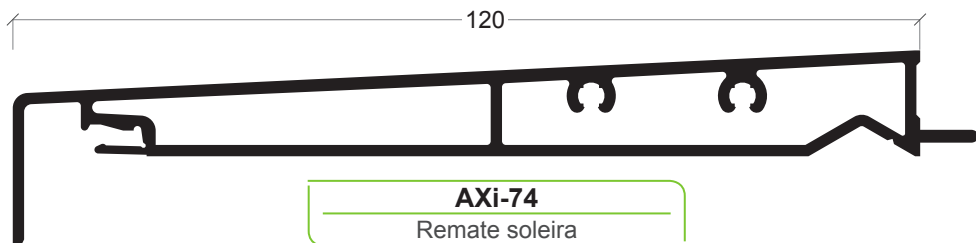

**AXi-74**  
Remate soleira

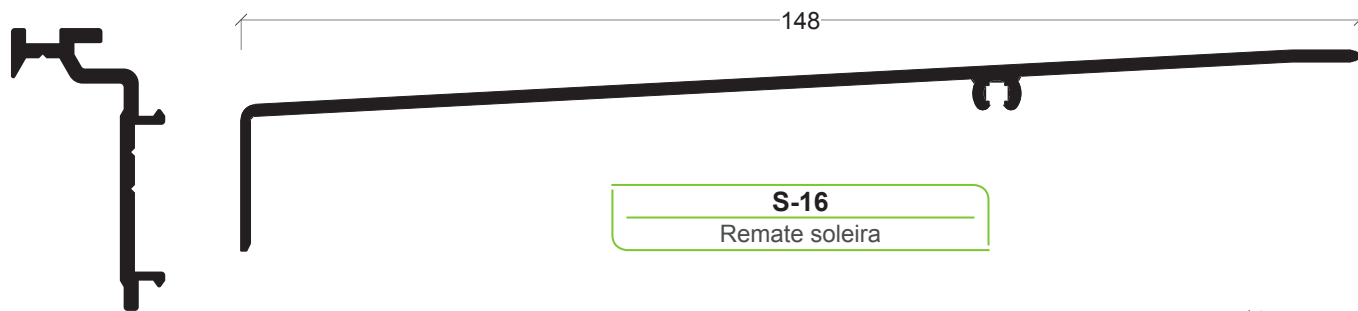

**S-16**  
Remate soleira

**ARi-26**  
Mola tapa juntas



**ARi-24**  
Mola tapa juntas

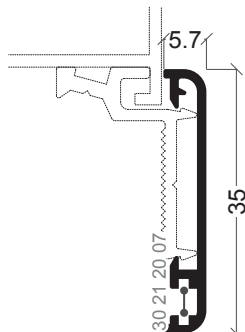

**ARi-30**  
Tapa juntas

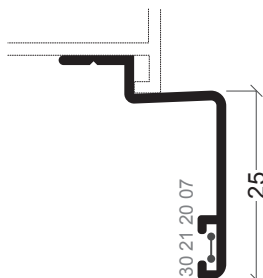

**ARi-66**  
Tapa juntas

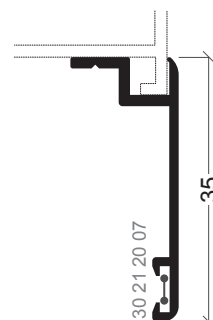

**ARi-31**  
Tapa juntas

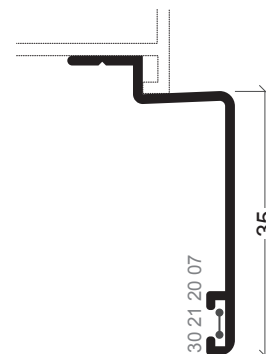

**ARi-37**  
Tapa juntas

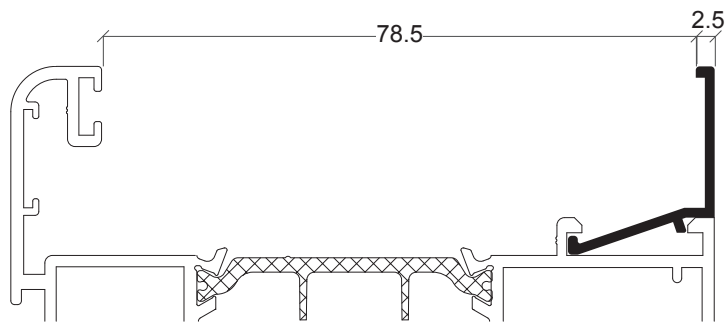

**AX-69**

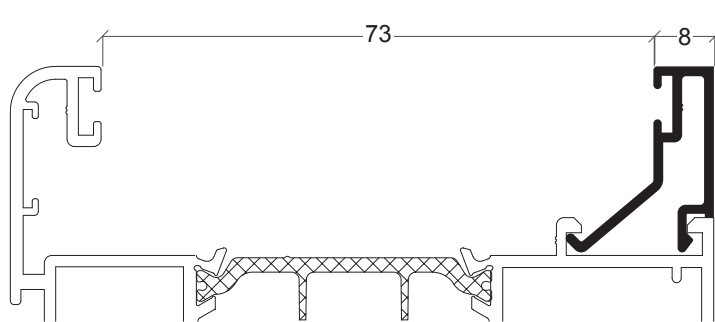

**AX-74**

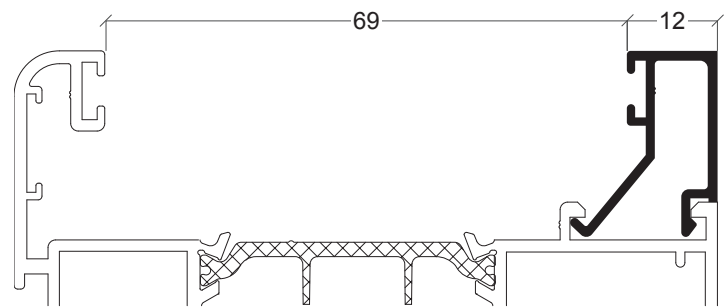

**AX-36**

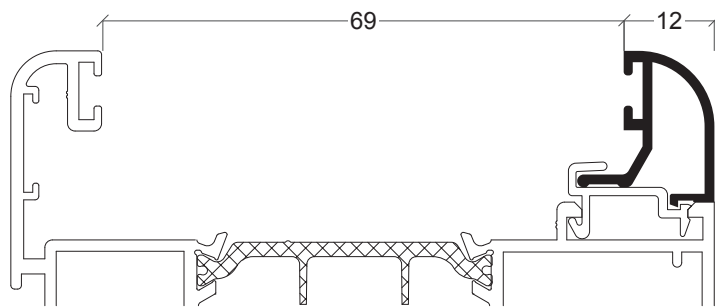

**AX-37**

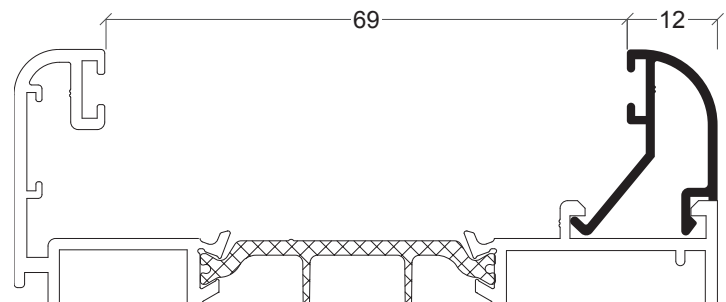

**AZ-08**

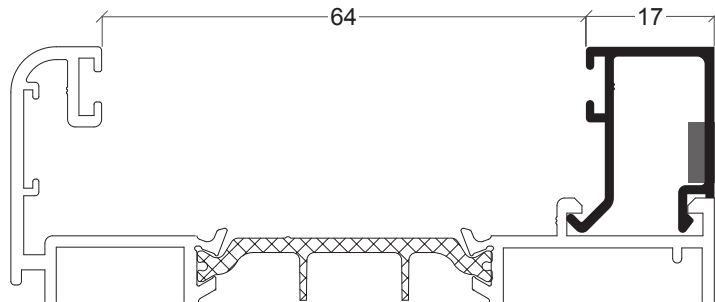

**AX-46**

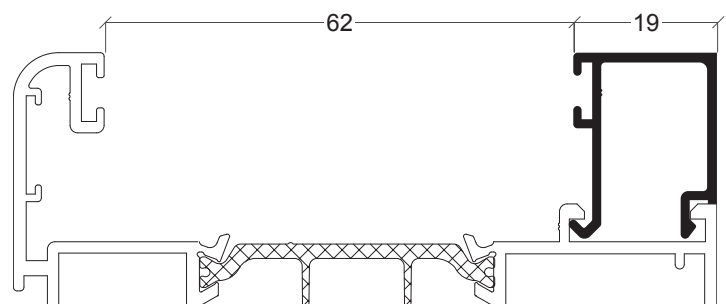

**AX-35**

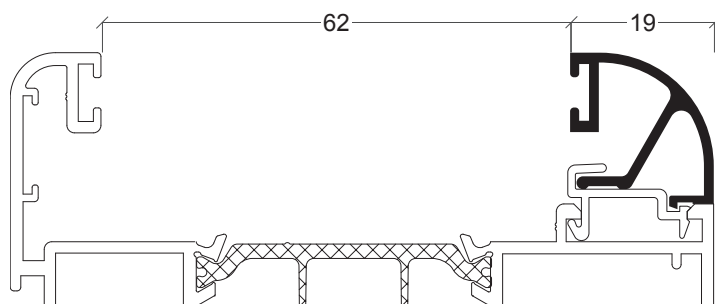

**AX-30**

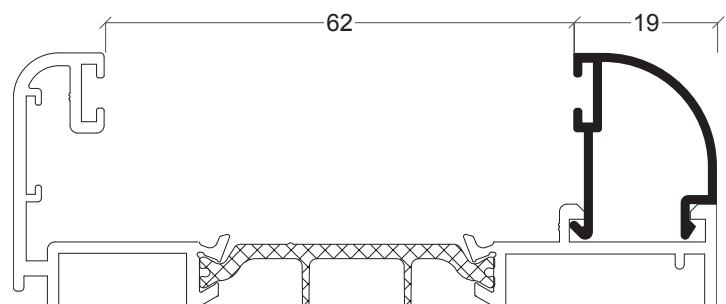

**AZ-07**

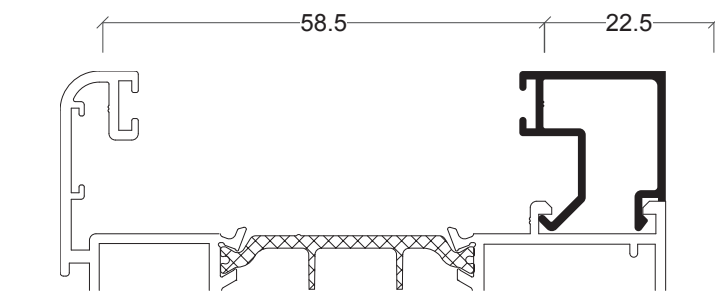

**AX-78**

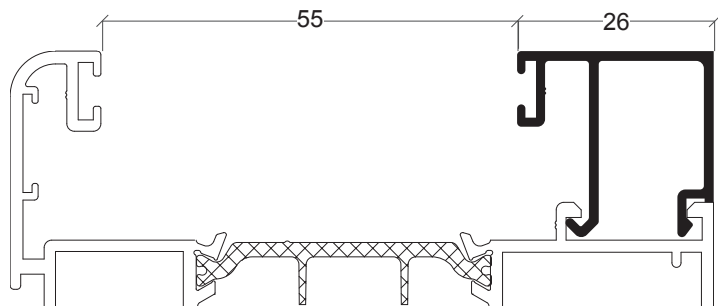

**AX-31**

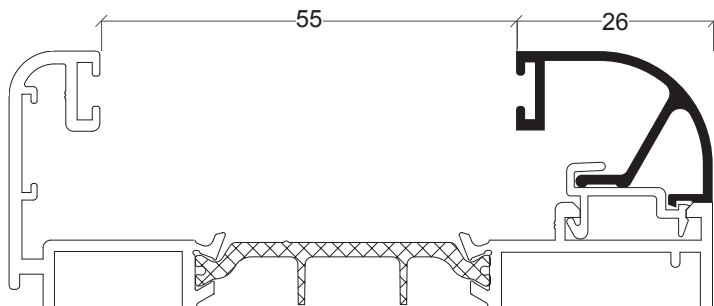

**AX-29**

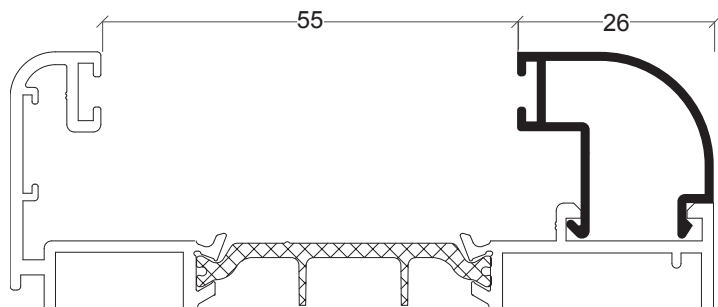

**AZ-06**

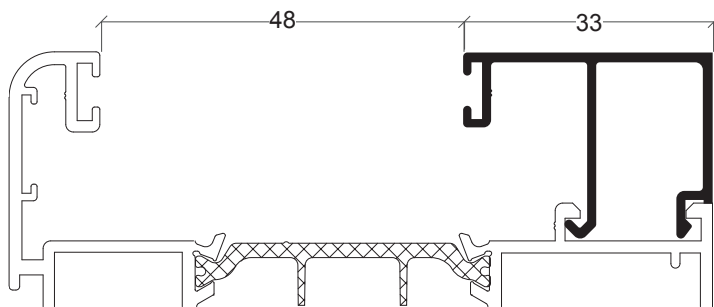

**AX-34**

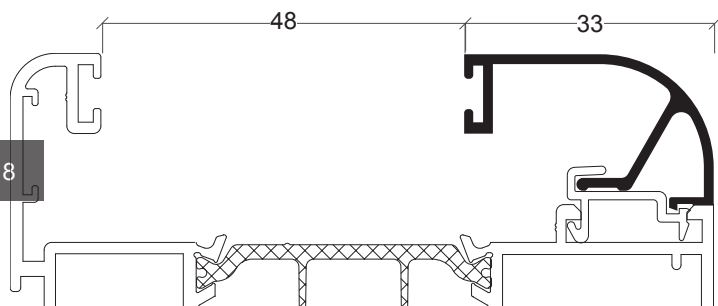

**AX-39**

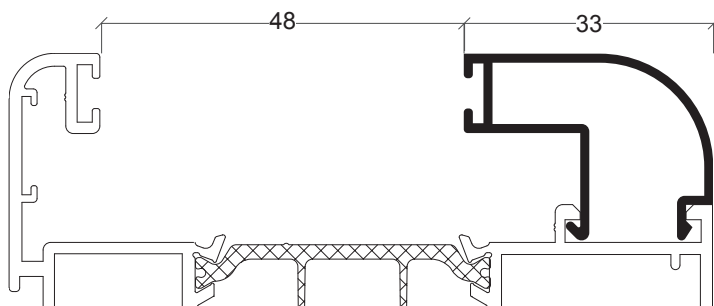

**AZ-28**

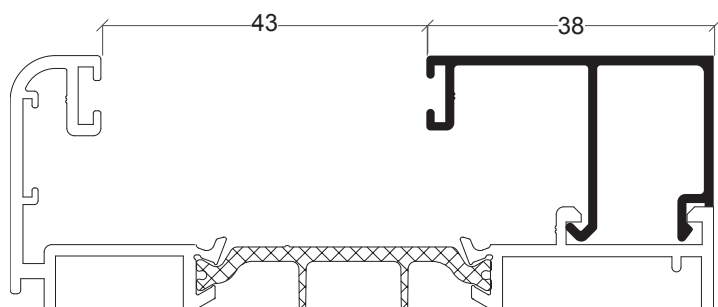

**AX-32**

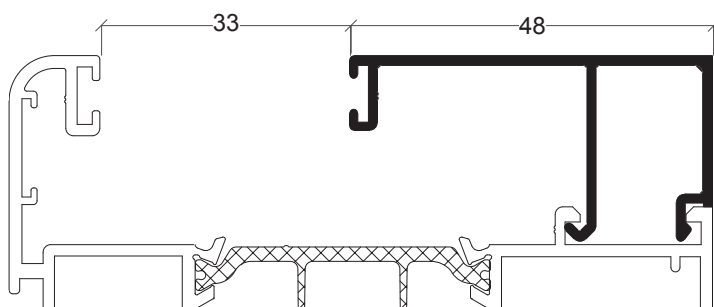

**AX-80**

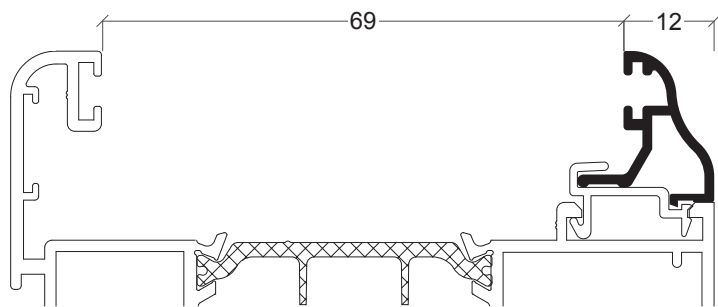

**AX-72**

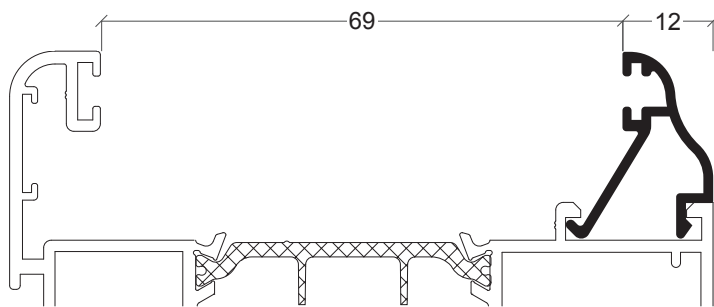

**AX-73**



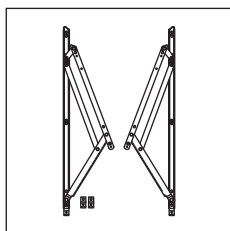

**30 00 95 21**  
Jogo compasso (180 kg)

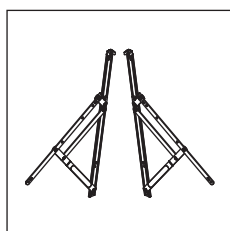

**30 00 95 71**  
Jogo compasso (60 kg)

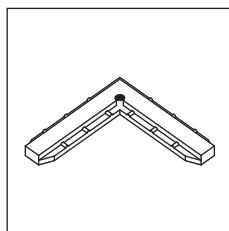

**30 21 20 07**  
Esquadro de alinhamento

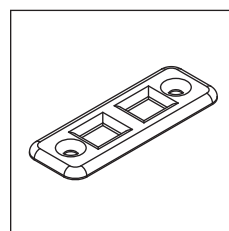

**30 24 30 75**  
Contra-fecho inox

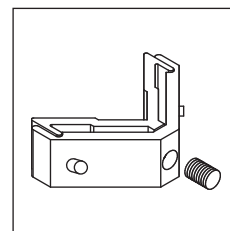

**30 60 00 01**  
Esquadro exterior janela

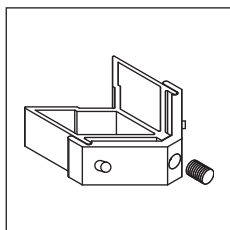

**30 60 00 02**  
Esquadro exterior porta

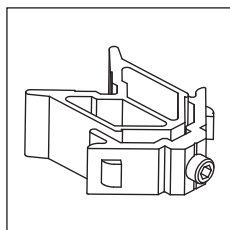

**30 60 00 03**  
Esquadro interior porta com clip

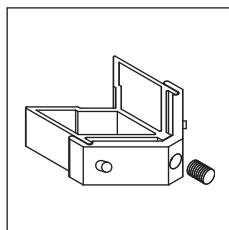

**30 60 00 04**  
Esquadro exterior porta

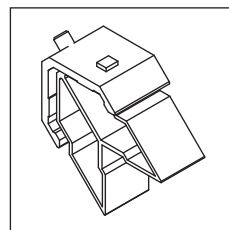

**30 60 00 05**  
Esquadro interior porta

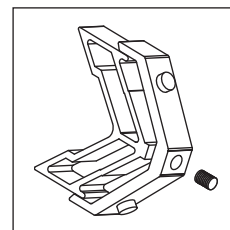

**30 60 00 06**  
Esquadro interior projectante

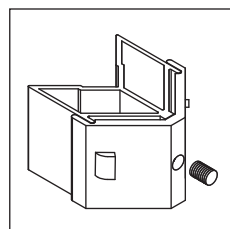

**30 60 00 07**  
Esquadro exterior projectante

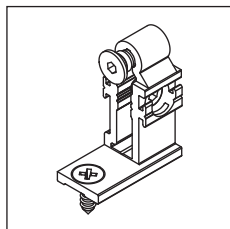

**30 60 00 08**  
União travessa exterior pequena fixo

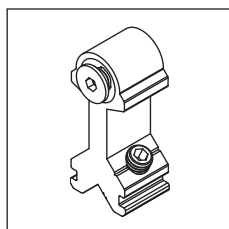

**30 60 00 09**  
União travessa interior pequena

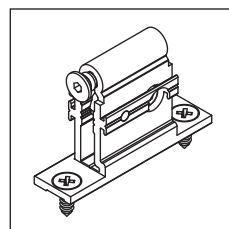

**30 60 00 10**  
União travessa exterior grande fixo/móvel

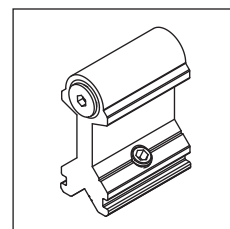

**30 60 00 11**  
União travessa interior grande

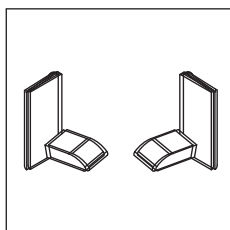

**30 60 00 13**  
Conjunto topos AJI-62

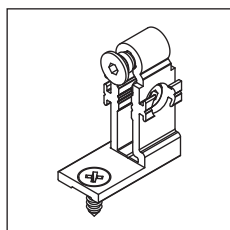

**30 60 00 16**  
União travessa exterior pequena móvel

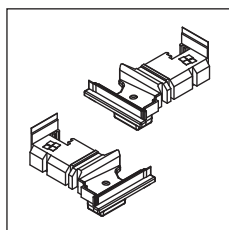

**30 70 00 12**  
Conjunto topos inversor API

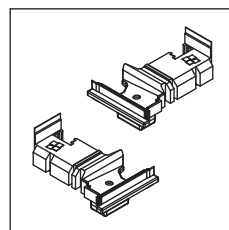

**30 70 00 15**  
Conjunto topos API-63

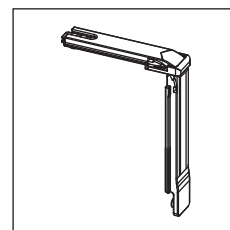

**30 90 20 42**  
Ângulo de reenvio

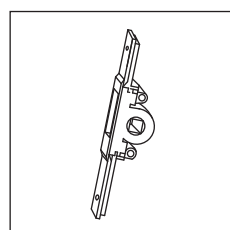

**30 90 20 44**  
Transmissão para abertura exterior

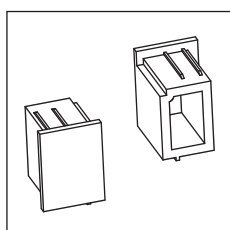

**30 91 21 20**  
Jogo topos condensação Y-20

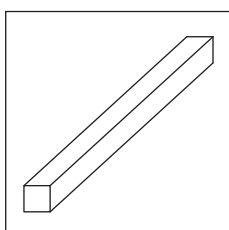

**30 91 41 23**  
Perno 7 x 131 mm

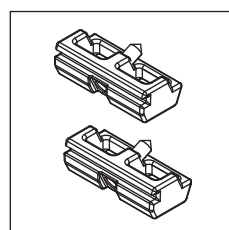

**30 92 00 50**  
Complemento fecho

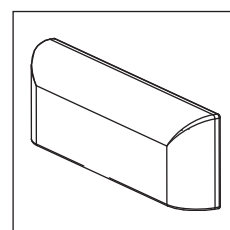

**30 92 01 00/01**  
Goteira preto/branco

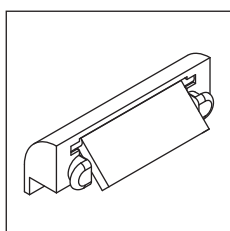

**30 92 01 02/03**  
Goteira com válvula preto /branco

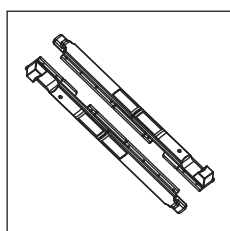

**30 92 01 20**  
Jogo fecho C.E.

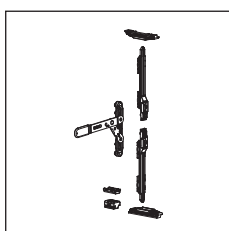

**30 92 01 23**  
Jogo de passadores bidireccional C.E.

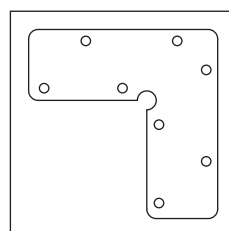

**30 92 01 35**  
Esquadro de alinhamento

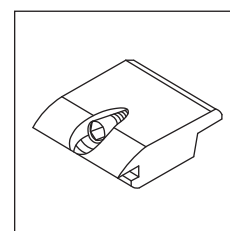

**30 92 02 60**  
Apoio da folha

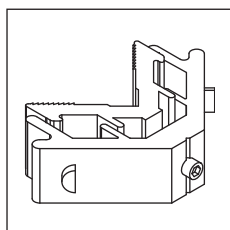

**30 92 04 25**

Esquadro interior janela fixo com clip

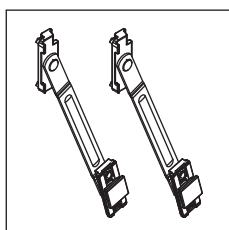

**30 92 04 75**

Jogo compassos basculante

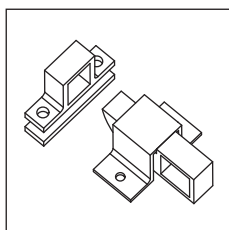

**30 92 04 76/77**

Fecho clack branco/preto

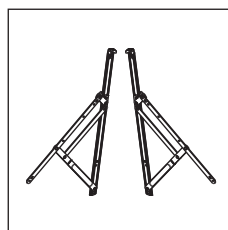

**30 92 04 80**

Compasso projectante deslizante até 50 kg / folha

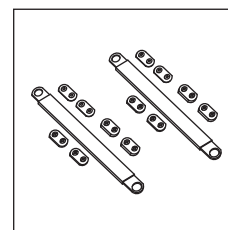

**30 92 04 85**

Jogo compassos

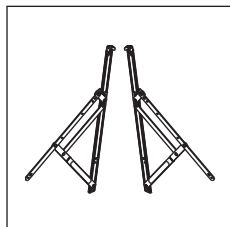

**30 92 04 90**

Compasso projectante deslizante até 70 kg / folha

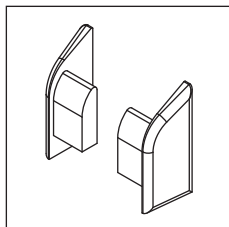

**30 92 05 00**

Jogo topos

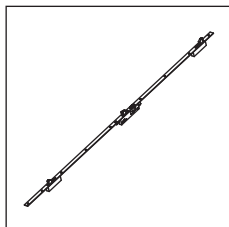

**30 92 05 10**

Fechadura 3 pontos (35 mm)

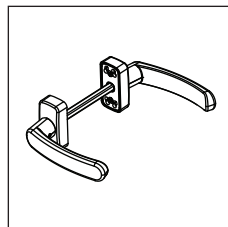

**30 92 05 15**

Fecho de alavanca com 5 pontos de fecho

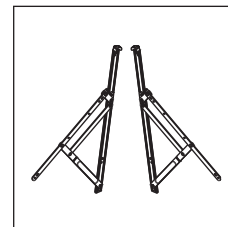

**30 92 06 00**

Compasso projectante deslizante até 20 kg / folha

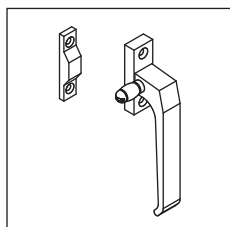

**30 92 06 10/11**

Cremona de lingueta branco/preto

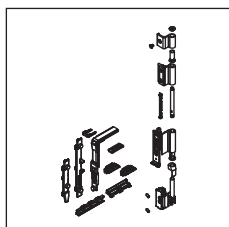

**30 92 12 56/57**

Kit OB Eco 80 kg sem cremone branco/preto

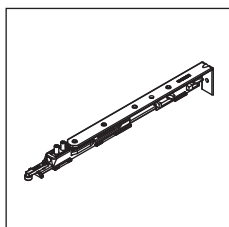

**30 92 12 58**

Compasso OB Eco 457-1300

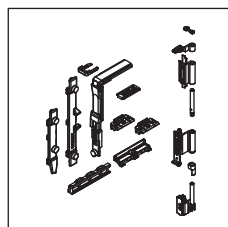

**30 92 12 60/61**

Kit OB sem cremone branco/preto

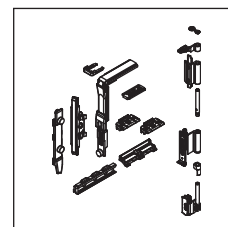

**30 92 12 62/63**

Kit OB sem puxador com transmissão branco/preto

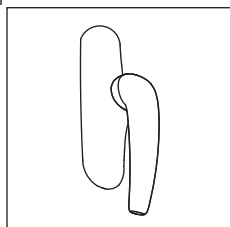

**30 92 12 64/65**

Cremona OB branco/preto

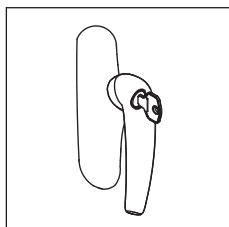

**30 92 12 66/67**

Cremona OB com chave branco/preto

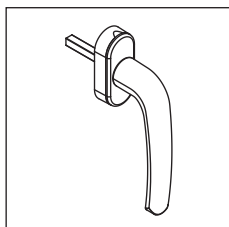

**30 92 12 68/69**

Puxador branco/preto

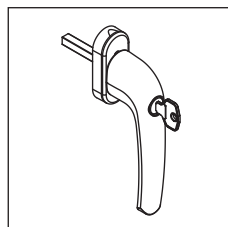

**30 92 12 70/71**

Puxador com chave branco/preto

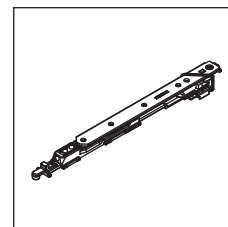

**30 92 12 72**

Compasso OB pequeno 457-550

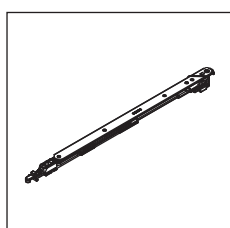

**30 92 12 73**

Compasso OB grande 551-1800

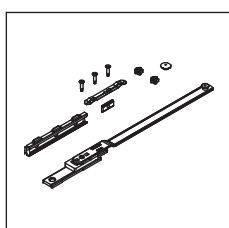

**30 92 12 74**

Compasso OB suplementar 1000-1800

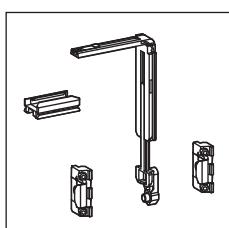

**30 92 12 75**

Kit fecho 3° ponto OB

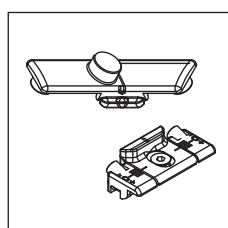

**30 92 12 76**

Ponto de fecho suplementar

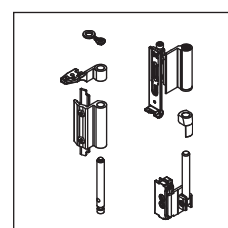

**30 92 12 77/78**

Kit dobradiça 2ª folha OB branco/preto

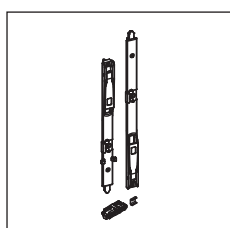

**30 92 12 79**

Conjunto de fechos 2ª folha OB

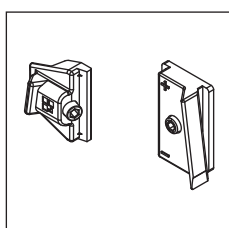

**30 92 12 80**

Conjunto de ponto de fecho suplementar passivo

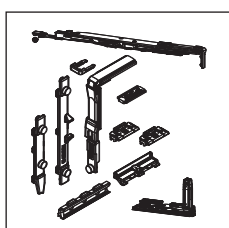

**30 92 12 81/82**

Kit OB oculto s/ cremone c/ compasso pequeno dir/esq

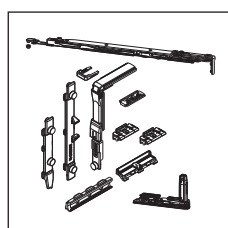

**30 92 12 83/84**

Kit OB oculto s/ cremone c/ compasso grande dir/esq

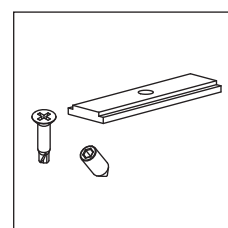

**30 92 12 85**

Suplemento OB oculto 131-170 kg

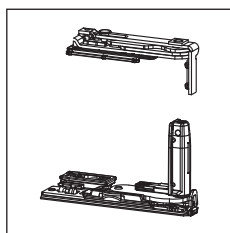

**30 92 12 86/87**

Kit dobradiça oculto 2ª  
folha dir/esq

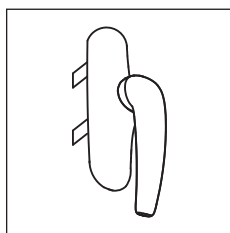

**30 92 12 88/89**

Cremone batente branco/  
preto

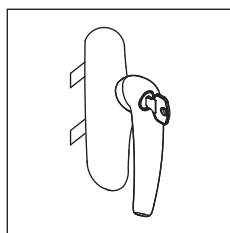

**30 92 12 90/91**

Cremone batente com  
chave branco/preto

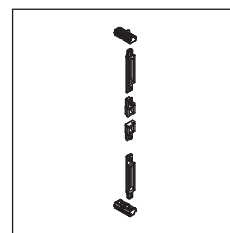

**30 92 12 92**

Kit batente sem cremone

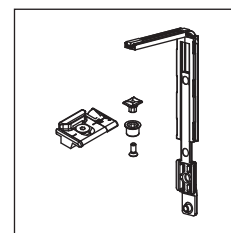

**30 92 12 93**

Kit fecho 3º ponto vertical  
OB oculto

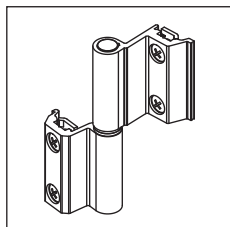

**30 92 12 94/95**

Dobradiça branco/preto

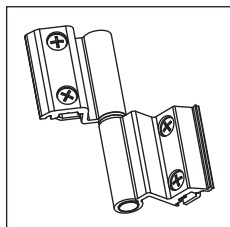

**30 92 12 96/97**

Dobradiça 3ª folha  
branco/preto

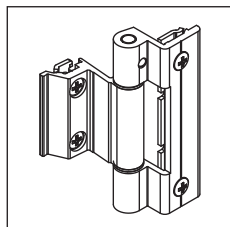

**30 92 12 98/99**

Dobradiça 3 nós branco/  
preto

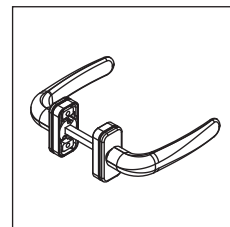

**30 92 13 00/01**

Puxador duplo branco/  
preto

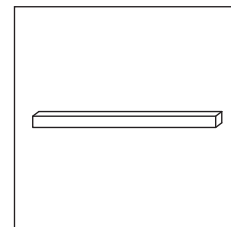

**30 92 13 02**

Perno 8 x 150 mm

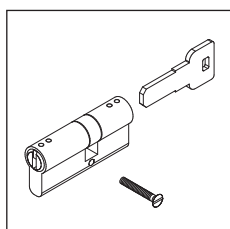

**30 92 13 03**

Canhão segurança 30 x  
80 Níquel

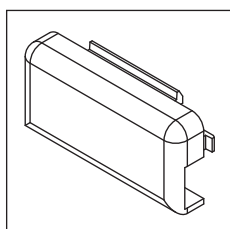

**30 92 13 04**

Goteira preta

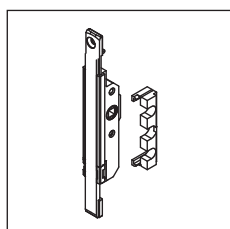

**30 92 13 05**

Transmissão bi-  
direccional

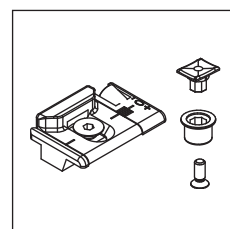

**30 92 13 06**

Ponto de fecho regulável

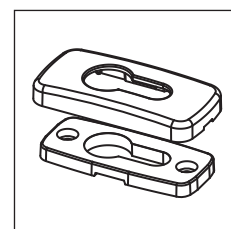

**30 92 22 85/86**

Escudo para canhão  
branco/preto

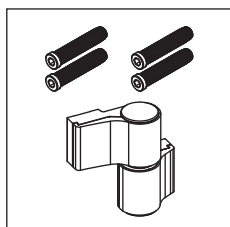

**30 92 22 88/89**

Dobradiça 2 abas porta c/ ressalto  
fixação directa branco/preto

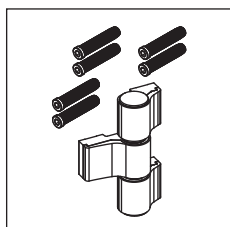

**30 92 22 90/91**

Dobradiça 3 abas porta c/ ressalto  
fixação directa branco/preto

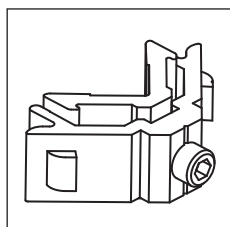

**30 96 00 04**

Esquadro interior janela

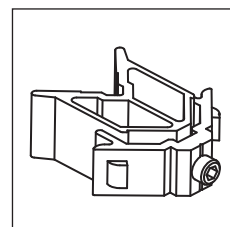

**30 96 00 05**

Esquadro interior aro fixo  
porta

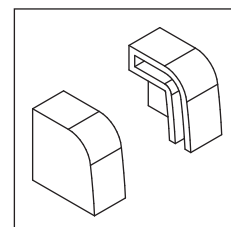

**30 96 00 12**

Jogo topos condensação

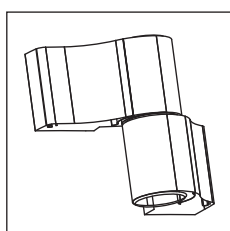

**30 96 00 17/21**

Dobradiça com ressalto  
branco/preto

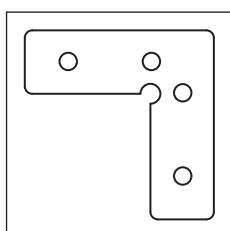

**30 96 00 22**

Esquadro alinhamento

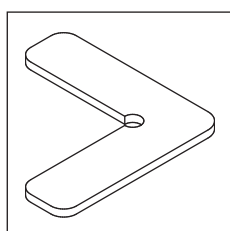

**30 96 00 23**

Esquadro alinhamento  
aro fixo

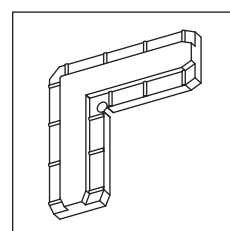

**30 96 00 43**

Esquadro alinhamento

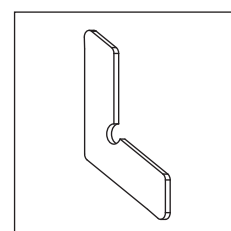

**30 96 00 63**

Esquadro alinhamento

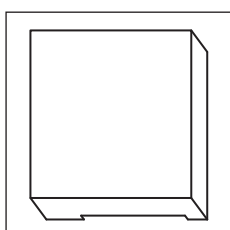

**30 96 10 01**

Calço para vidro aro  
móvel

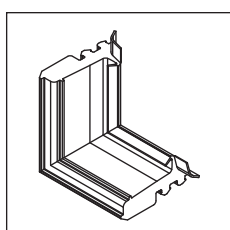

**30 96 10 07**

Canto vulcanizado

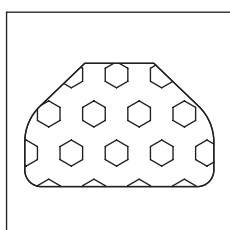

**30 99 00 01**

ThermoProfile ISO-01

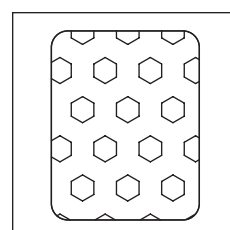

**30 99 00 02**

ThermoProfile ISO-02

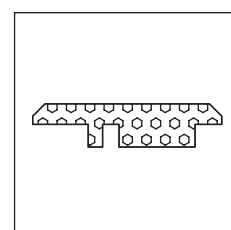

**30 99 00 06**

ThermoProfile ISO-06

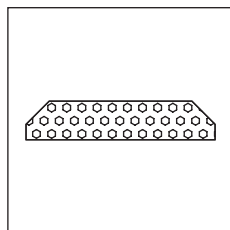

**30 99 00 07**  
ThermoProfile ISO-07

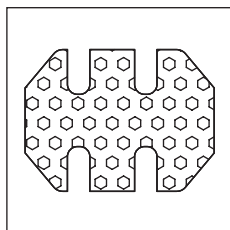

**30 99 00 10**  
ThermoProfile ISO-10

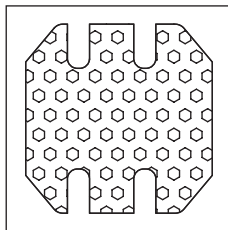

**30 99 00 13**  
ThermoProfile ISO-13

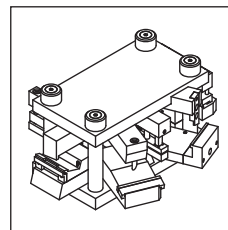

**33 98 22 99**  
Cunho APi

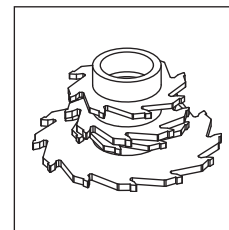

**33 98 31 99**  
Conjunto de frezas fixo

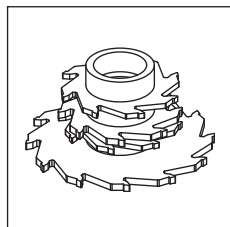

**33 98 32 99**  
Conjunto de frezas móvel

Referência	Desenho	Descrição
30 00 95 15		Junta de vedação curta AZ-79
30 60 00 14		Perfil pelúcia metálica 18 mm preto
30 60 00 17		Junta exterior vidro plana 2 mm preto
30 60 00 18		Junta Isolante
30 92 04 70		Espuma isolante
30 93 00 60		Junta exterior do vidro (4 mm) preto
30 93 00 61		Junta de vedação exterior (2 mm) preto
30 93 00 62		Junta exterior plana para vidro (4 mm) preto
30 93 00 65		Junta interior para vidro (5 mm) preto
30 93 00 66		Junta interior para vidro (4 mm) preto
30 93 00 67		Junta interior para vidro (2 mm) preto
30 93 00 68		Junta interior para vidro (6/7 mm) preto
30 93 00 69		Junta interior para vidro (8/9 mm) preto
30 93 00 82		Junta vedação inferior AZ-79
30 93 01 20		Junta interior
30 94 01 46		Junta para veda-luz AZ-22
30 95 00 10		Pelúcia 7x9 mm
30 96 00 18		Junta interior (abertura projectante/deslizante)
30 96 10 06		Junta central termo isolante

Referência	ThermoProfile (Baguetes de 70 cm)	Aplicação
30 99 00 01		APi-01; APi-03; APi-04; APi-05; APi-07; APi-21; APi-33; APi-35; APi-61; APi-65; APi-67; APi-71; APi-73; APi-74; APi-75; APi-76; APi-80; APi-81; APi-83; APi-86; APi-87; APi-88; APi-89; APi-91; APi-95
30 99 00 02		APi-01; APi-03; APi-04; APi-05; APi-07; APi-21; APi-33; APi-35; APi-61; APi-65; APi-67; APi-71; APi-73; APi-74; APi-75; APi-76; APi-80; APi-81; APi-83; APi-86; APi-87; APi-88; APi-89; APi-91; APi-95
30 99 00 06		APi-01; APi-03; APi-06; APi-08; APi-12; APi-20; APi-33; APi-35; APi-68; APi-73; APi-74; APi-75; APi-76; APi-79; APi-80; APi-81; APi-86; APi-87; APi-88; APi-89; APi-91; APi-92; APi-93; APi-94
30 99 00 07		APi-05; APi-07; APi-10; APi-36; APi-61; APi-72; APi-83; APi-84; APi-85; APi-90; APi-95
30 99 00 10		APi-06; APi-08; APi-68; APi-79; APi-92; APi-93; APi-94
30 99 00 13		APi-10; APi-36; APi-72; APi-84; APi-85; APi-90

## Janela 1 folha abrir e oscilo-batente

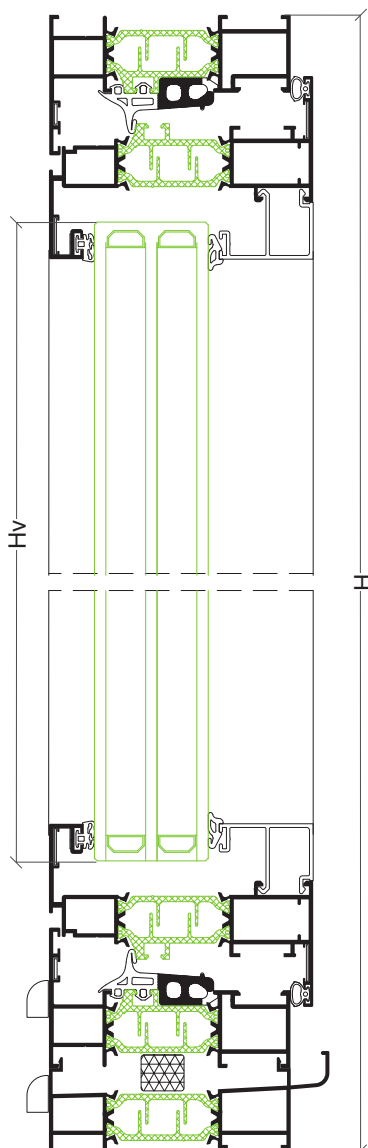
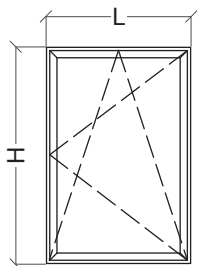

### Perfis

Desenho	Ref	Descrição	Corte	Quant	Medida
	API-03	Aro fixo		2	L
				2	H-28.5 mm
	API-61	Aro móvel		2	L-43 mm
				2	H-71.5 mm
	---	Bite		2	L-132 mm
				2	H-200.5 mm
	AX-19	Vareta		várias	---
	API-71	Soleira		1	L

### Acessórios e Juntas

Referência	Descrição	Quantidade	
		Abrir	Oscilo-batente
30 96 00 04	Esquadro interior		8
30 60 00 01	Esquadro exterior		8
30 96 00 23	Esquadro alinhamento fixo		4
30 96 00 22	Esquadro alinhamento móvel		8
30 96 10 01	Calço para vidro	4	6
30 92 12 64/65	Cremona OB	---	1
30 92 12 88/89	Cremona batente branco/preto	1	---
---	Ferragem oscilo-batente (ver páginas 27/28)	---	1
30 92 12 92	Kit batente	1	---
30 92 12 94/95	Dobradiça branco/preto	2 ou mais	---
30 92 13 06	Ponto de fecho regulável (H > 1100 mm)	1	---
30 92 02 60	Apoio da folha	1	---
30 92 01 02	Goteira com válvula preto		4 ou mais
30 96 00 12	Jogo topos condensação		1
30 92 04 70	Espuma isolante		L
30 93 01 20	Junta interior		2L+2H
30 96 10 06	Junta central termo isolante		2L+2H
30 96 10 07	Canto vulcanizado		4
---	Junta para vidro (exterior)		2L+2H
---	Junta para vidro (interior)		2L+2H

173

### Vidro



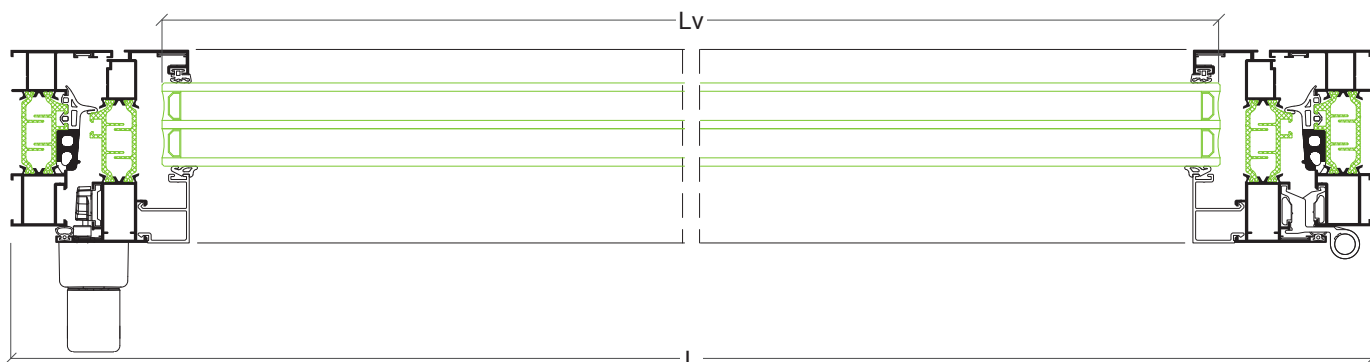



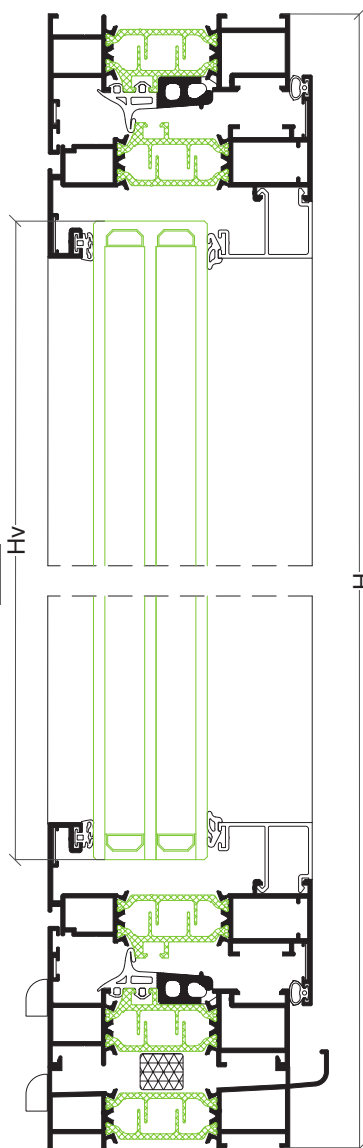
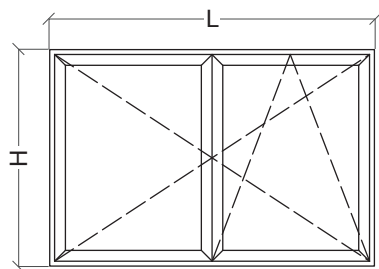



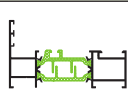

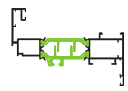



Hv = H-174 mm	Lv = L-146 mm
---------------	---------------



## Janela 2 folhas abrir e oscilo-batente



### Perfis

Desenho	Ref	Descrição	Corte	Quant	Medida
	API-03	Aro fixo		2	L
				2	H-28.5 mm
	API-61	Aro móvel		2	L/2-24 mm
				2	H-71.5 mm
	---	Bite		4	L/2-113 mm
				4	H-200.5 mm
	AX-19	Vareta		várias	---
	API-04	Inversor		1	H-139.5 mm
	KL-04	Perfil tampa		1	H-139.5 mm
	API-71	Soleira		1	L

### Acessórios e Juntas

Referência	Descrição	Quantidade	
		Abrir	Oscilo-batente
30 96 00 04	Esquadro interior		12
30 60 00 01	Esquadro exterior		12
30 96 00 23	Esquadro alinhamento fixo		4
30 96 00 22	Esquadro alinhamento móvel		16
30 96 10 01	Calço para vidro	8	12
30 92 12 64/65	Cremona OB	---	1
---	Ferragem oscilo-batente (ver páginas 27/28)	---	1
30 92 12 92	Kit batente	1	---
30 92 01 20	Jogo fecho C.E.	1	---
30 92 12 94/95	Dobradiça branco/preto	4 ou mais	---
30 92 13 06	Ponto de fecho regulável (H > 1100 mm)	1	---
30 92 02 60	Apoio da folha	1	---
30 70 00 12	Conjunto topos inversor		1
30 96 10 06	Junta central termo isolante		2L+3H
30 96 10 07	Canto vulcanizado		4
30 92 01 02	Goteira com válvula preto		4 ou mais
30 96 00 12	Jogo topos condensação		1
30 92 04 70	Espuma isolante		L
30 93 01 20	Junta interior		2L+4H
---	Junta para vidro (exterior)		2L+4H
---	Junta para vidro (interior)		2L+4H

### Vidro

Hv = H-174 mm	Lv = L/2-127 mm
---------------	-----------------

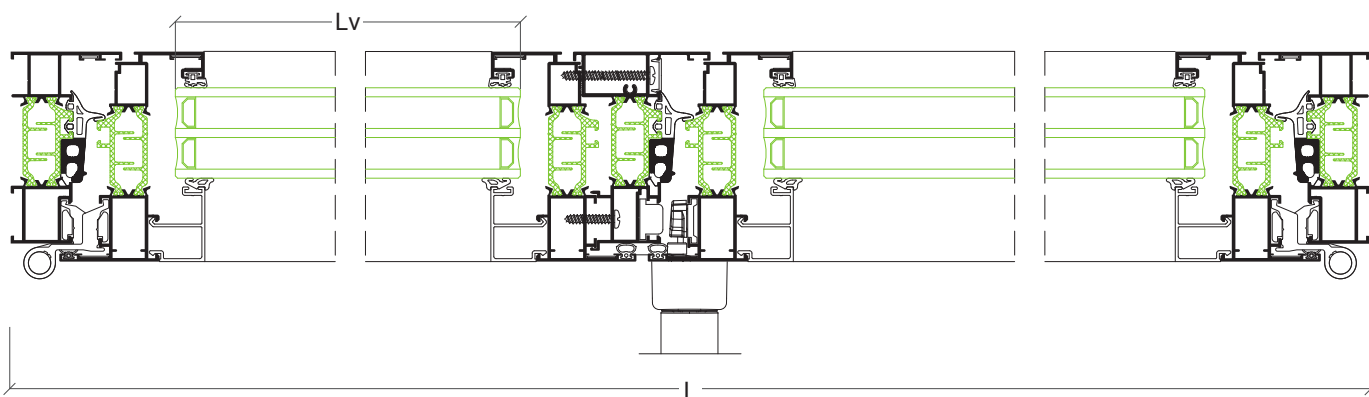

## Janela projectante

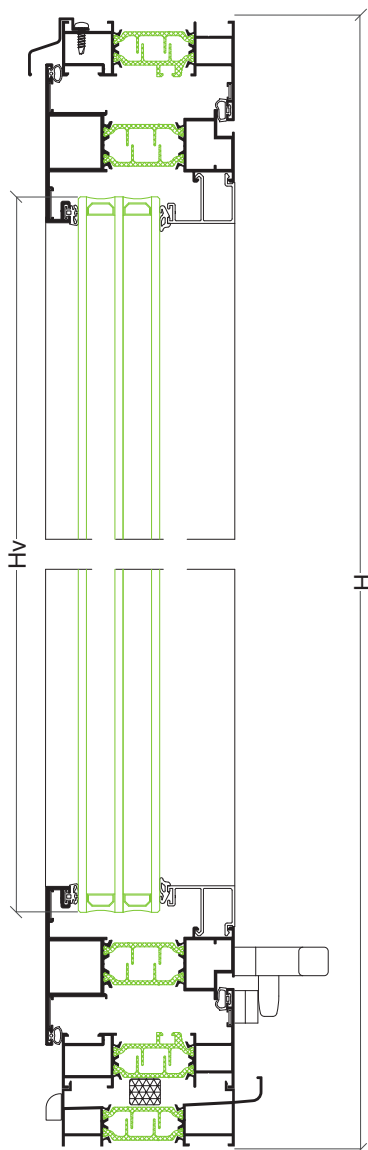
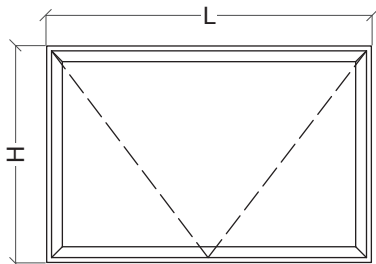

### Perfis

Desenho	Ref	Descrição	Corte	Quant	Medida
	API-03	Aro fixo		2	L
				2	H-28.5 mm
	API-95	Aro móvel		2	L-43 mm
				2	H-71.5 mm
	---	Bite		2	L-159.5 mm
				2	H-228 mm
	API-71	Soleira		1	L
	AXi-45	Pingadeira		1	L
	AXi-32	Complemento		1	segundo medida do compasso

### Acessórios e Juntas

Referência	Descrição	Quantidade
30 96 00 04	Esquadro interior	4
30 60 00 01	Esquadro exterior	4
30 96 00 23	Esquadro alinhamento fixo	4
30 92 01 35	Esquadro alinhamento móvel	8
30 96 00 06	Esquadro interior	4
30 96 00 07	Esquadro exterior	4
30 96 10 01	Calço para vidro	4
30 96 06 10 ou 11	Cremona de lingueta	2
---	Jogo compasso projectante	1
30 92 01 02	Goteira com válvula preto	2 ou mais
30 96 00 12	Jogo topos condensação	1
30 92 04 70	Espuma isolante	L
30 93 01 20	Junta exterior	2L+2H
30 96 00 18	Junta interior projectante deslizante	2L+2H
---	Junta para vidro (exterior)	2L+2H
---	Junta para vidro (interior)	2L+2H

175

### Vidro



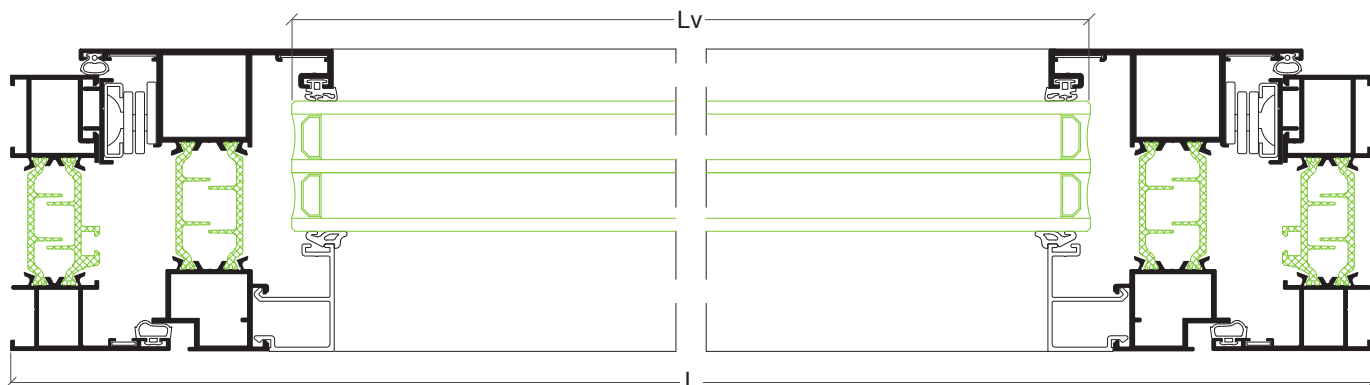



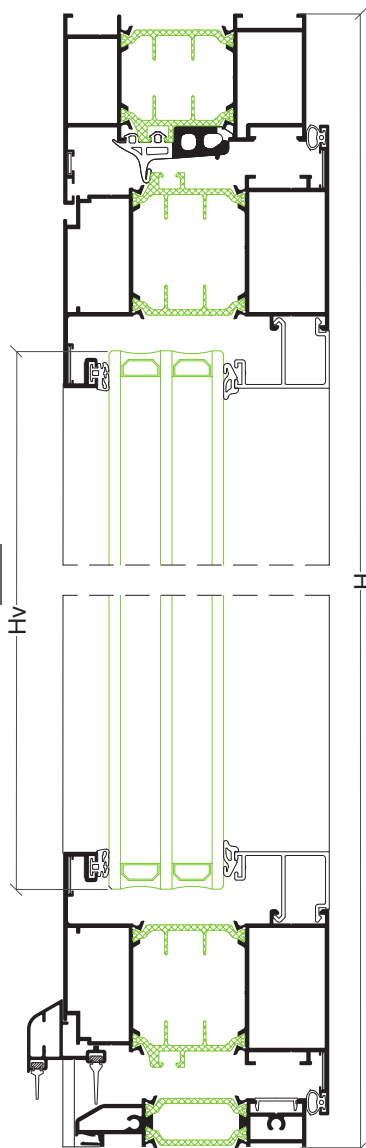
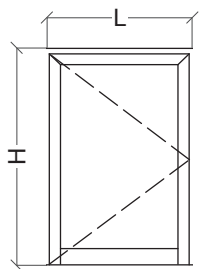



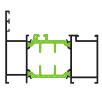

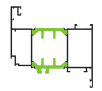

Hv = H-202 mm	Lv = L-173 mm
---------------	---------------



## Porta 1 folha



### Perfis

Desenho	Ref	Descrição	Corte	Quant	Medida
	API-08	Aro fixo		1	L
				2	H
	API-36	Aro móvel		2	L-78 mm
				2	H-50 mm
	---	Bite		2	L-222 mm
				2	H-234 mm
	API-63	Remate inferior porta		1	L-80.5 mm
	AZ-79	Pingadeira		1	L-135 mm
	KL-04	Perfil tampa		1	L-90 mm

### Acessórios e Juntas

Referência	Descrição	Quantidade
30 96 00 05	Esquadro interior	2
30 60 00 02	Esquadro exterior	2
30 60 00 05	Esquadro interior móvel	4
30 60 00 04	Esquadro exterior móvel	4
30 96 00 23	Esquadro alinhamento fixo	2
30 96 00 22	Esquadro alinhamento móvel	8
30 96 10 01	Calço para vidro	4
30 92 22 88 ou 89	Dobradiça 2 abas porta	2
30 92 05 10	Fechadura 3 pontos	1
30 92 13 00 ou 01	Puxador duplo	1
30 92 13 02	Perno	1
30 92 22 85 ou 86	Escudo para canhão	1
30 92 13 03	Canhão	1
30 93 01 20	Junta interior	2L+2H
30 96 10 06	Junta central	L+2H
30 96 10 07	Canto vulcanizado	2
30 92 05 00	Conjunto topos pingadeira	1
30 00 95 15	Junta inferior curta	L
30 93 00 82	Junta inferior	L
---	Junta para vidro (exterior)	2L+2H
---	Junta para vidro (interior)	2L+2H

### Vidro

Hv = H-208 mm	Lv = L-236 mm
---------------	---------------

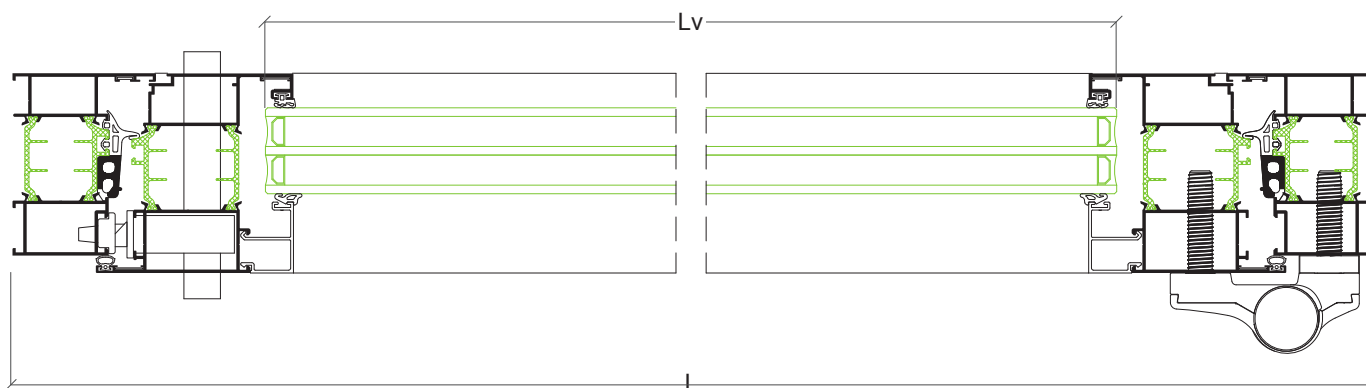



## Porta 2 folhas

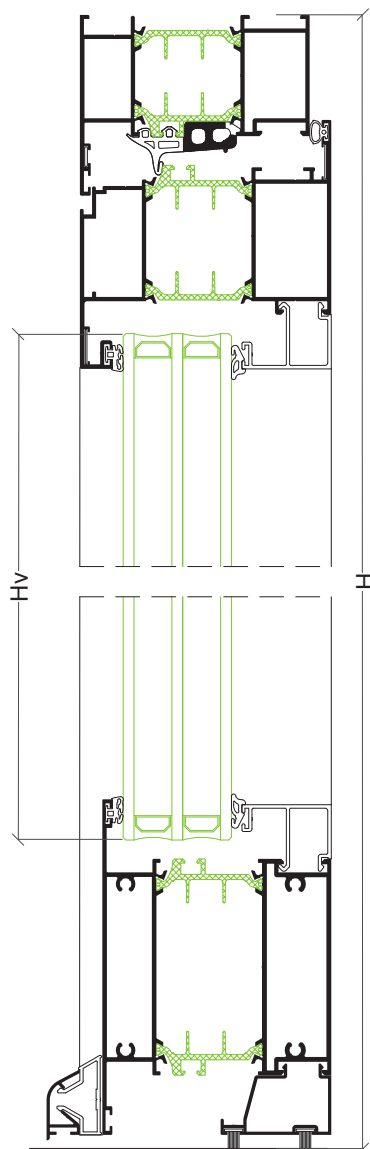
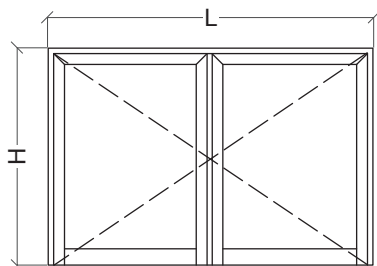

### Perfis

Desenho	Ref	Descrição	Corte	Quant	Medida
	API-08	Aro fixo		1	L
				2	H
	API-36	Aro móvel		2	L/2-41.5 mm
				4	H-44 mm
	---	Bite		4	L/2-185.5 mm
				4	H-258 mm
	API-04	Inversor		1	H-78 mm
	KL-04	Perfil tampa		1	H-78 mm
	API-12	Travessa		2	L/2-176.5 mm
	AJi-82	Bite remate		2	L/2-185.5 mm
	AZ-60	Pingadeira		1	L/2-103 mm
				1	L/2-39 mm
	AZ-61	Suplemento pingadeira		2	L/2-226 mm

### Acessórios e Juntas

Referência	Descrição	Quantidade
30 96 00 05	Esquadro interior	2
30 60 00 02	Esquadro exterior	2
30 60 00 05	Esquadro interior móvel	4
30 60 00 04	Esquadro exterior móvel	4
30 96 00 23	Esquadro alinhamento fixo	2
30 96 00 22	Esquadro alinhamento móvel	8
30 70 00 12	Conjunto topos inversor	1
30 92 22 88 ou 89	Dobradiça 2 abas porta	4
30 92 05 10	Fechadura 3 pontos	1
30 92 13 00 ou 01	Puxador duplo	1
30 92 13 02	Perno	1
30 92 22 85 ou 86	Escudo para canhão	1
30 92 13 03	Canhão	1
30 92 00 50	Contra-fecho	1
30 24 30 75	Contra-fecho inferior	1
30 92 01 20	Jogo fecho C.E.	1
30 93 01 20	Junta interior	L+4H
30 96 10 06	Junta central	L+3H
30 96 10 07	Canto vulcanizado	2
30 92 05 00	Conjunto topos pingadeira	1
30 95 00 10	Pelúcia	2L
---	Junta para vidro (exterior)	2L+4H
---	Junta para vidro (interior)	2L+4H

177

### Vidro

Hv = H-232 mm	Lv = L/2-200 mm
---------------	-----------------

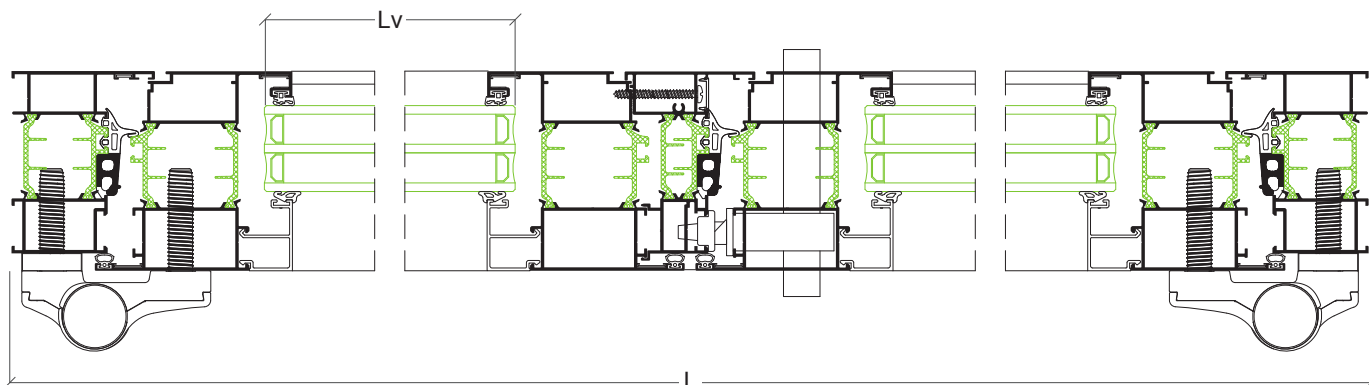

## Porta 1 folha abertura exterior

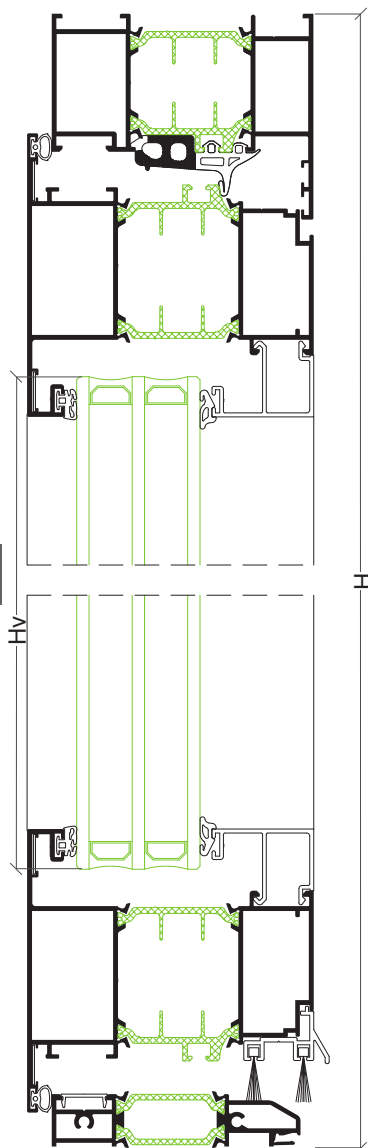
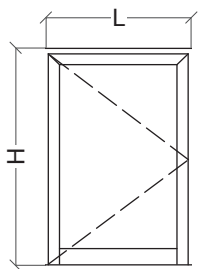

### Perfis

Desenho	Ref	Descrição	Corte	Quant	Medida
	API-08	Aro fixo		1	L
				2	H
	API-72	Aro móvel		2	L-78 mm
				2	H-50 mm
	---	Bite		2	L-222 mm
				2	H-234 mm
	API-63	Remate inferior porta		1	L-80.5 mm
	AJi-62	Pingadeira		1	---
	KL-04	Perfil tampa		1	L-90 mm

### Acessórios e Juntas

Referência	Descrição	Quantidade
30 96 00 05	Esquadro interior	2
30 60 00 02	Esquadro exterior	2
30 60 00 05	Esquadro interior móvel	4
30 60 00 04	Esquadro exterior móvel	4
30 96 00 23	Esquadro alinhamento fixo	2
30 96 00 22	Esquadro alinhamento móvel	8
30 96 10 01	Calço para vidro	4
30 92 22 88 ou 89	Dobradiça 2 abas porta	2
30 92 05 10	Fechadura 3 pontos	1
30 92 13 00 ou 01	Puxador duplo	1
30 92 13 02	Perno	1
30 92 22 85 ou 86	Escudo para canhão	1
30 92 13 03	Canhão	1
30 93 01 20	Junta interior	2L+2H
30 96 10 06	Junta central	L+2H
30 96 10 07	Canto vulcanizado	2
30 60 00 13	Conjunto topos AJi-62	1
30 60 00 14	Pelúcia preta 18 mm	2L
---	Junta para vidro (exterior)	2L+2H
---	Junta para vidro (interior)	2L+2H

### Vidro

Hv = H-208 mm	Lv = L-236 mm
---------------	---------------

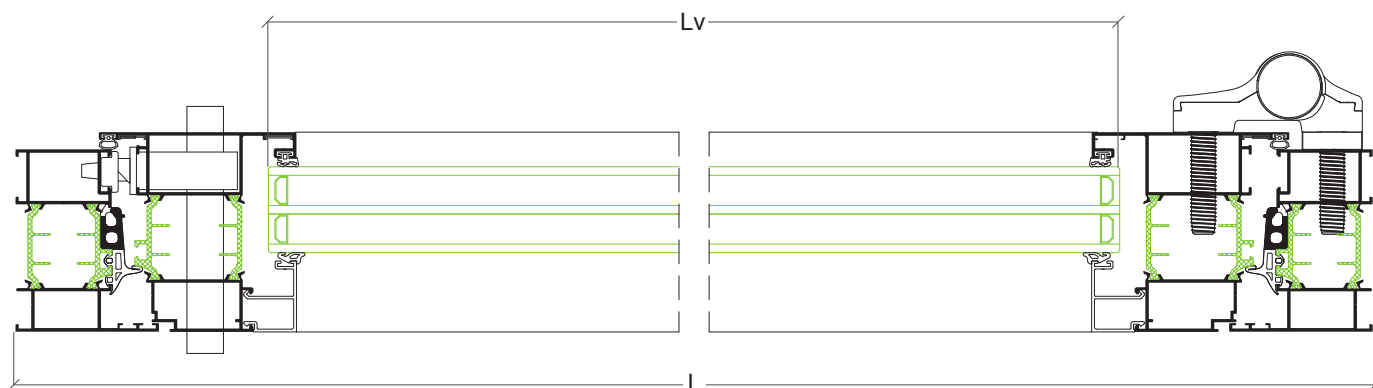

## Ferragens para oscilo-batente

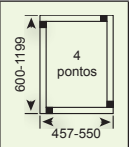
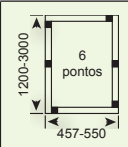
Designação	Referência		
Kit oscilo-batente	30 92 12 60 (branco) 30 92 12 61 (preto)	1	
Cremone OB	30 92 12 64 ou 65 ou 30 92 12 66 ou 67	1	
Compasso pequeno	30 92 12 72	1	
Kit fecho 3º ponto	30 92 12 75		1

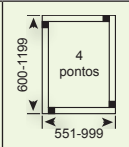
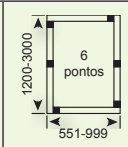
Designação	Referência		
Kit oscilo-batente	30 92 12 60 (branco) 30 92 12 61 (preto)	1	
Cremone OB	30 92 12 64 ou 65 ou 30 92 12 66 ou 67	1	
Compasso grande	30 92 12 73	1	
Kit fecho 3º ponto	30 92 12 75		1

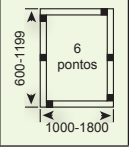
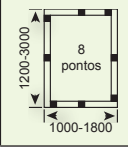
Designação	Referência		
Kit oscilo-batente	30 92 12 60 (branco) 30 92 12 61 (preto)	1	
Cremone OB	30 92 12 64 ou 65 ou 30 92 12 66 ou 67	1	
Compasso grande	30 92 12 73	1	
Compasso suplementar	30 92 12 74	1	
Kit fecho 3º ponto	30 92 12 75	1	2

## Ferragens para a 2ª folha

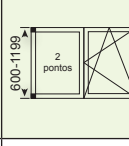
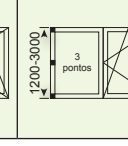
Designação	Referência		
Kit dobradiça 2ª folha	30 92 12 77 (branco) 30 92 12 78 (preto)	1	
Kit fechos para 2ª folha	30 92 12 79	1	
Conjunto ponto fecho suplementar	30 92 12 80		1

### Peso máximo da folha: 130 kg (alumínio + vidro)

(confirmar com o quadro de dimensão/aplicação do mapa de montagem da ferragem O-B)

Largura mínima: 457 mm / Largura máxima: 1800 mm  
 Altura mínima: 600 mm / Altura máxima: 3000 mm

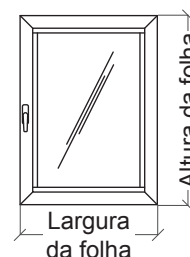
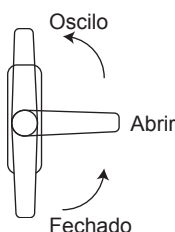

## Ferragens para oscilo-batente oculta

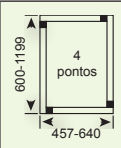
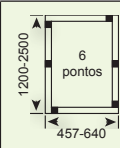
Designação	Referência		
Kit oscilo-batente com compasso pequeno (até 130 kg)	30 92 12 81 (direito) 30 92 12 82 (esquerdo)		1
Cremone OB	30 92 12 64 ou 65 ou 30 92 12 66 ou 67		1
Suplemento (131 - 170 kg)	30 92 12 85		1
Kit fecho 3º ponto vertical	30 92 12 93		1

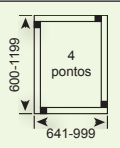
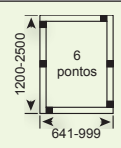
Designação	Referência		
Kit oscilo-batente com compasso grande (até 130 kg)	30 92 12 83 (direito) 30 92 12 84 (esquerdo)		1
Cremone OB	30 92 12 64 ou 65 ou 30 92 12 66 ou 67		1
Suplemento (131 - 170 kg)	30 92 12 85		1
Kit fecho 3º ponto vertical	30 92 12 93		1

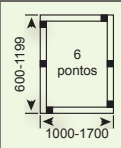
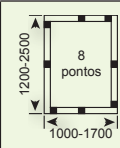
Designação	Referência		
Kit oscilo-batente com compasso grande (até 130 kg)	30 92 12 83 (direito) 30 92 12 84 (esquerdo)		1
Cremone OB	30 92 12 64 ou 65 ou 30 92 12 66 ou 67		1
Suplemento (131 - 170 kg)	30 92 12 85		1
Compasso suplementar	30 92 12 74		1
Kit fecho 3º ponto horizontal	30 92 12 75		1
Kit fecho 3º ponto vertical	30 92 12 93		1

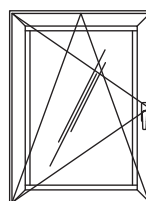

abertura esquerda

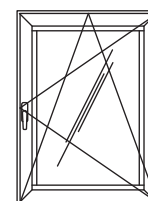

abertura direita

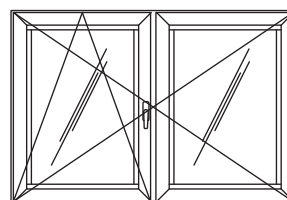

abertura esquerda

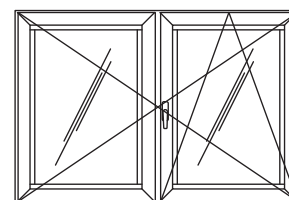

abertura direita

## Ferragens para a 2ª folha

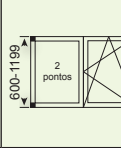
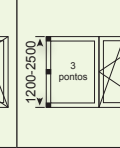
Designação	Referência		
Kit dobradiça 2ª folha (até 130 kg)	30 92 12 86 (direito) 30 92 12 87 (esquerdo)		1
Kit fechos para 2ª folha	30 92 12 79		1
Conjunto ponto fecho suplementar	30 92 12 80		1
Suplemento (131-170 kg)	30 92 12 85		1

### Peso máximo da folha: 170 kg (alumínio + vidro)

(confirmar com o quadro de dimensão/aplicação do mapa de montagem da ferragem O-B)

Largura mínima: 457 mm / Largura máxima: 1700 mm

Altura mínima: 600 mm / Altura máxima: 2500 mm

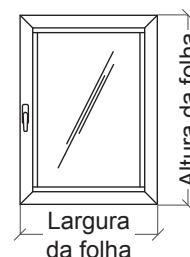
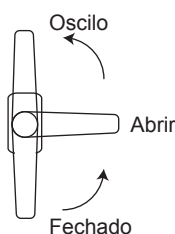

As medidas indicadas reportam-se às dimensões da folha móvel do vão