

Sistema
CT

Sistema CT

Sistema de correr com RPT - 60 mm

Características do sistema

Sistema de alumínio com rotura térmica para execução de vãos de correr.

Perfis de alumínio

Os perfis de alumínio são extrudidos na liga de alumínio 6060 para arquitectura de acordo com norma NP EN 12020-02.

Os perfis com rotura térmica são obtidos por inserção de varetas isolantes de poliamida 6.6 mm reforçadas com 25% de fibra de vidro. Versátil sistema de rotura térmica com aros e folhas perimetrais ou de corte recto designado por Benelux, é o sistema indicado para as inovadoras soluções arquitectónicas da actualidade.

Espessura média dos perfis de alumínio de 1.5 mm.

Aros fixos

Secção do aro fixo perimetral de 2 guias de 60 mm para montagem a meia esquadria;

Perfis com rotura térmica obtida por inserção de varetas isolantes de poliamida de 14.6 mm ou 18 mm;

Perfil guia de deslizamento inferior em aço inoxidável 304 ou em poliamida, para evitar desgaste das peças.

Aros móveis

Secção dos aros móveis perimetrais de 33.1 mm para montagem a meia esquadria;

Enchimento de 18 mm a 26 mm;

Aros móveis de linha recta ou curva com ou sem bite;

Estanquidade assegurada através de junta em TPE e/ou pelúcia tipo Sin-Feal.

Dimensionamento e manobralidade

Peso máximo de 150 kg por folha (com 2 rolamentos duplos);

Possibilidades de abertura: 2, 3, 4 e 6 folhas com folhas móveis e/ou fixas;

Rolamento duplo oscilante com regulação;

Rolamentos de agulhas inox com eixo temperado rectificando sendo possível a substituição sem desmontagem da folha;

Suporte exterior com tratamento cataforese (anti-corrosivo);

Abertura do vão com fecho lateral ou ferragem multi-ponto com 2 ou 4 pontos de fecho.

Performances

Sistema certificado por laboratório notificado do ensaio tipo inicial (ITT) de acordo com a norma de produto EN 14351-1 para efeitos de Marcação CE.

Categorias alcançadas na avaliação do sistema CT tipologia janela:

1. Permeabilidade ao ar: Classe 3 (norma de ensaio EN 1026)
2. Estanquidade à água: Classe 7A (norma de ensaio EN 1027)
3. Resistência ao vento: Classe C5 (norma de ensaio EN 12211)

Categorias alcançadas na avaliação do sistema CT tipologia porta:

1. Permeabilidade ao ar: Classe 4 (norma de ensaio EN 1026)
2. Estanquidade à água: Classe 7A (norma de ensaio EN 1027)
3. Resistência ao vento: Classe C2 (norma de ensaio EN 12211)

Coefficiente de transmissão térmica de vão de 2 folhas com 1.80 m x 2.20 m com vidro $U_g = 1.0 \text{ W/m}^2\text{K}$ com intercalar efeito "Warm Edge":

• $U_w = 1.91 \text{ W/m}^2\text{K}$

Coefficiente de atenuação acústica de vão de 2 folhas com vidro 6/14/33.1 acústico:

• $R_w (C; C_{tr}) = 34 \text{ dB} (-1; -6)$

Zonas de aplicação segundo RCCTE (em função do valor U_g): I1, I2, I3, V1, V2, V3;

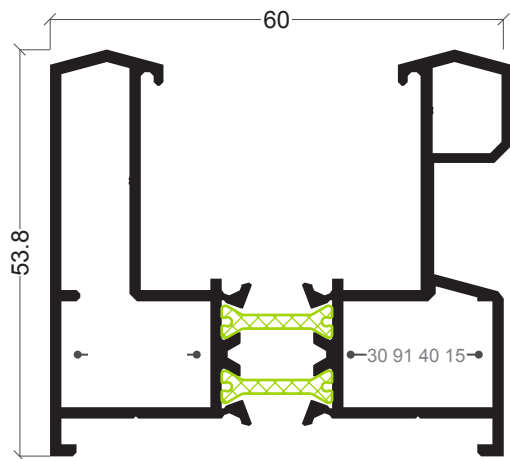

CT-01
Aro fixo perimetral

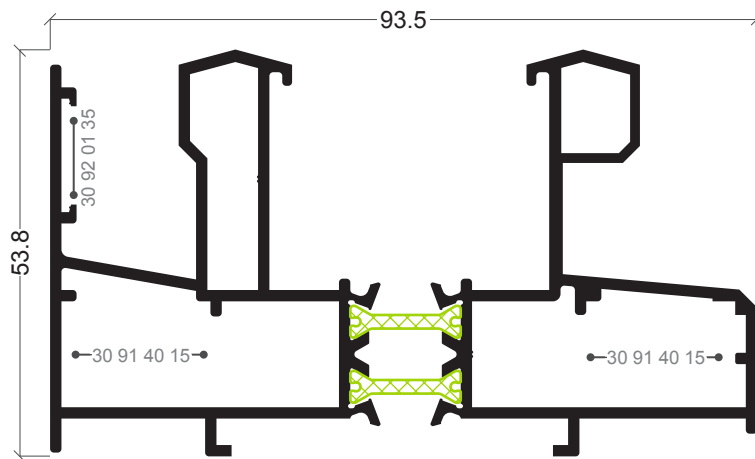

CT-16
Aro fixo perimetral

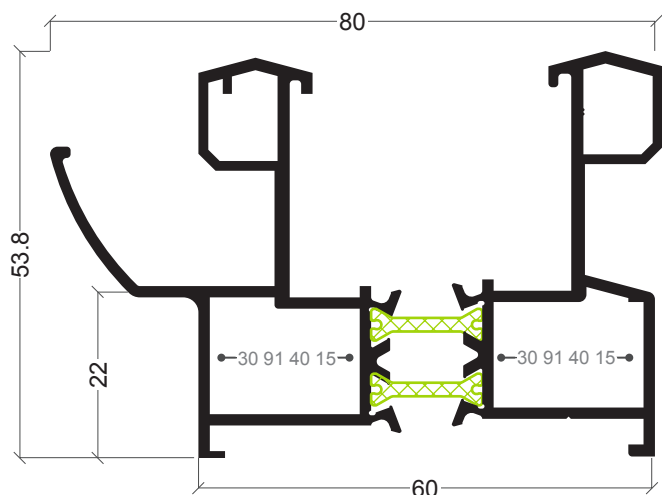

CT-15
Aro fixo perimetral

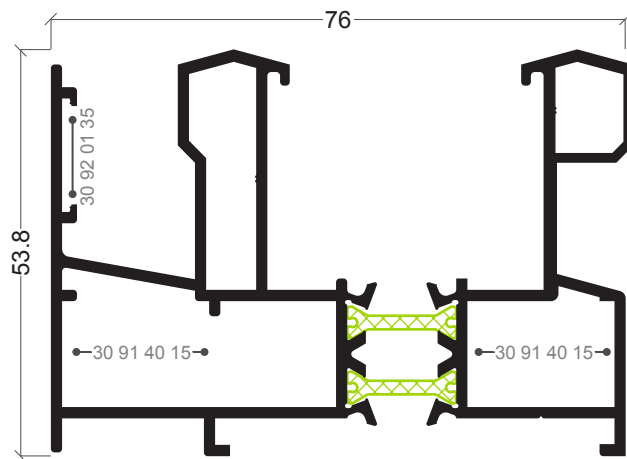

CT-22
Aro fixo perimetral

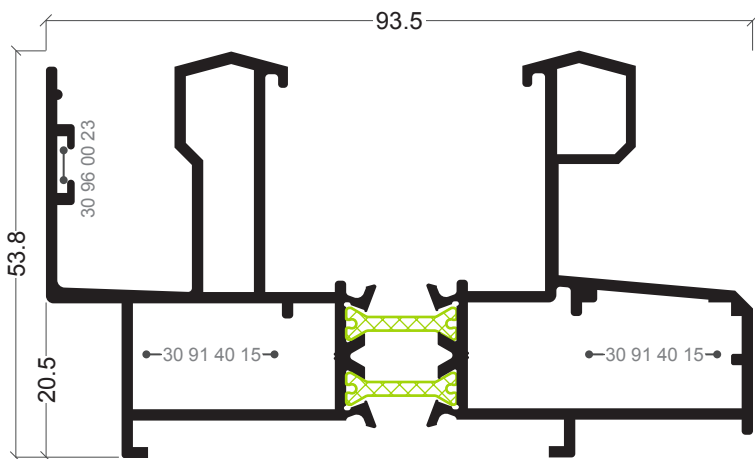

CT-17
Aro fixo perimetral

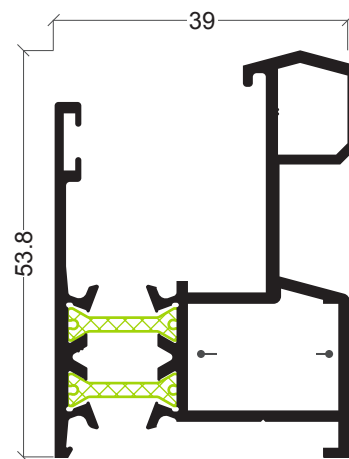

CT-59
Aro fixo perimetral mono-rail

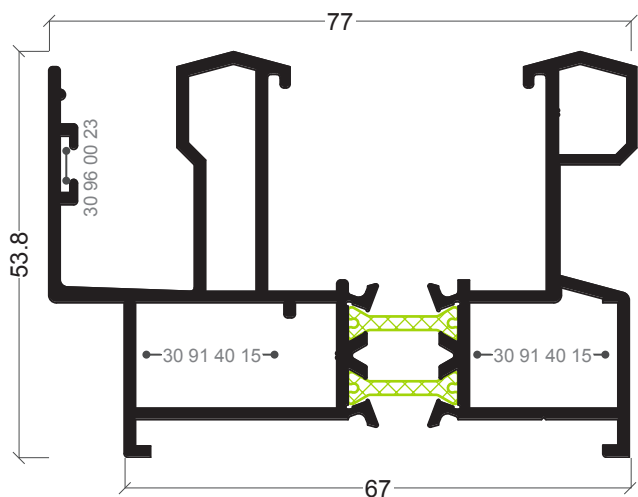

CT-60
Aro fixo perimetral

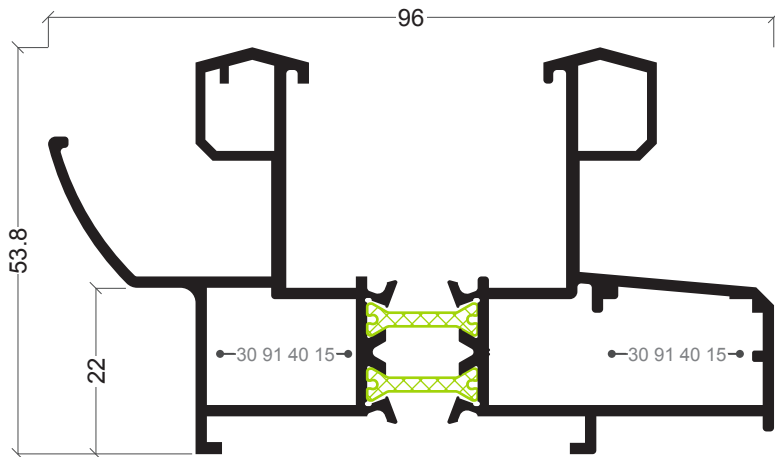

CT-20
Aro fixo perimetral

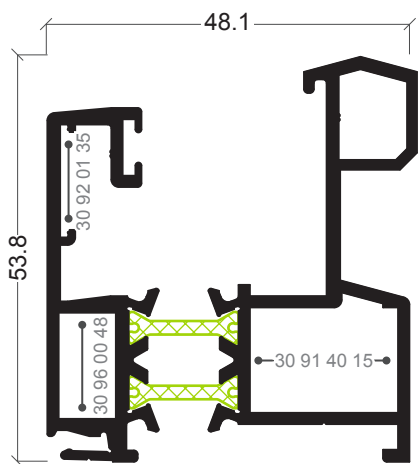

CT-66
Aro fixo monorail

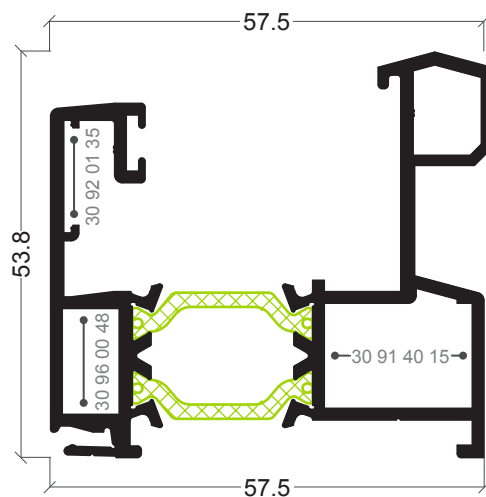

CT-70
Aro fixo monorail galandage

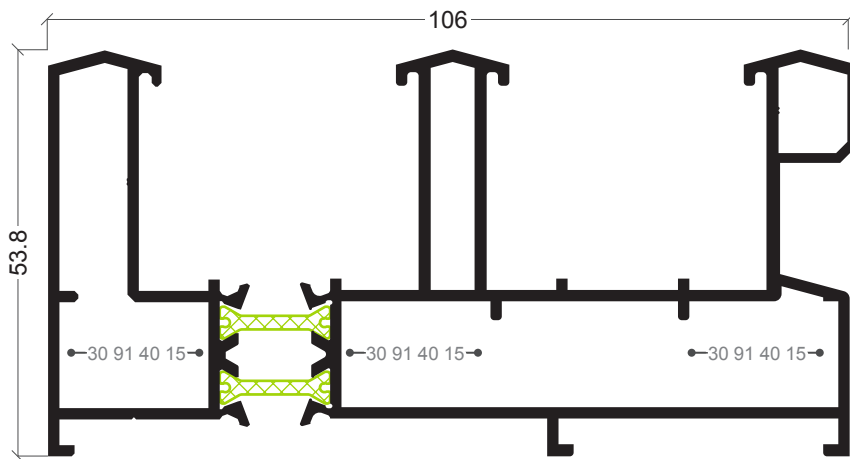

CT-14
Aro fixo perimetral tri-rail

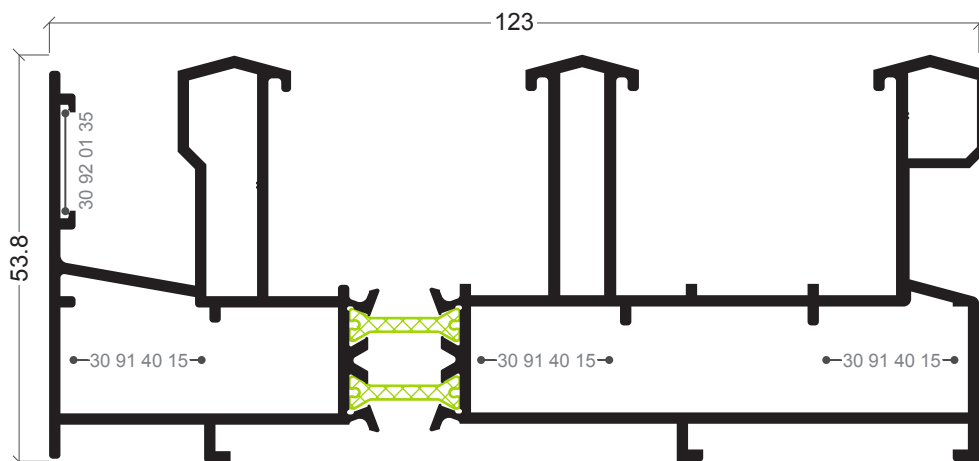

CT-18
Aro fixo perimetral tri-rail

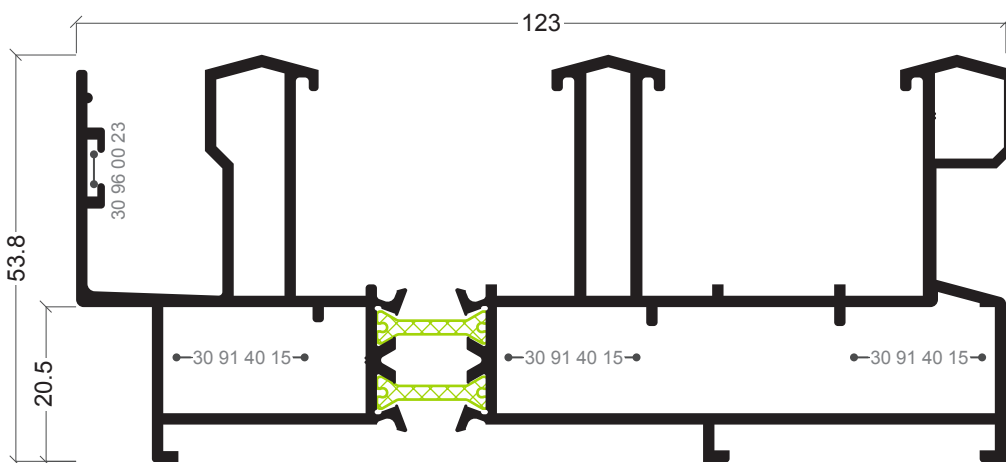

CT-19
Aro fixo perimetral tri-rail

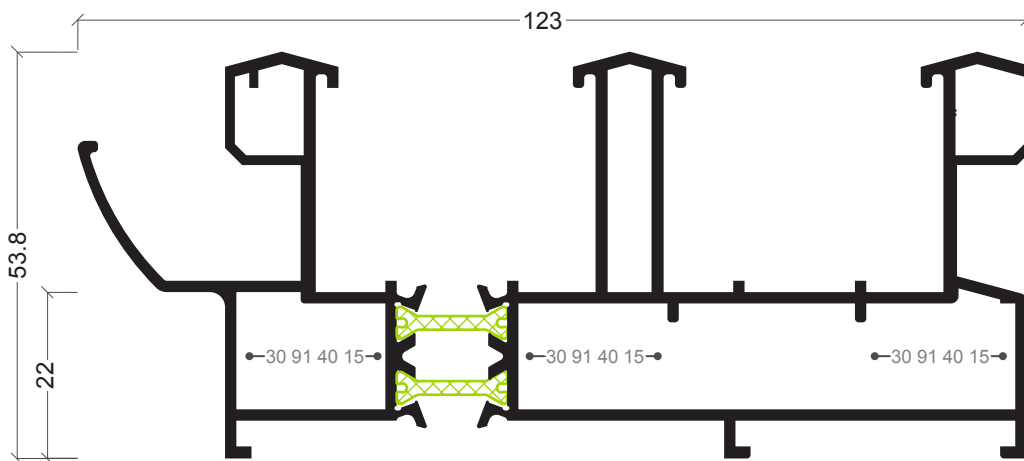

CT-21
Aro fixo perimetral tri-rail

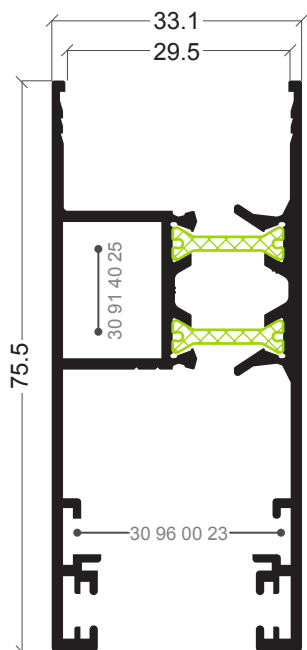

CT-53
Aro fixo perimetral recto

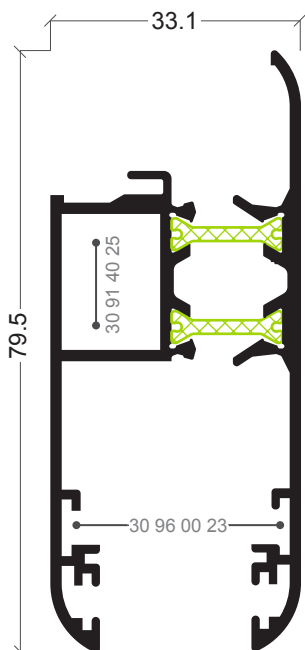

CT-02
Aro móvel perimetral c/ bite

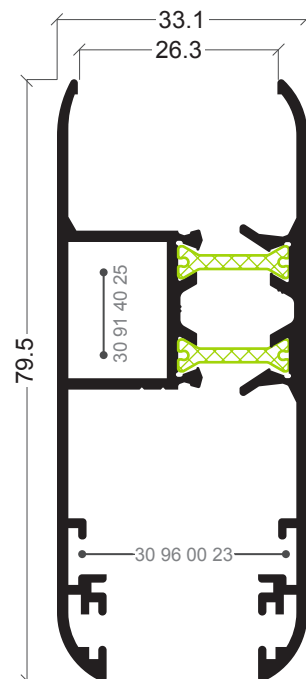

CT-12
Aro móvel perimetral

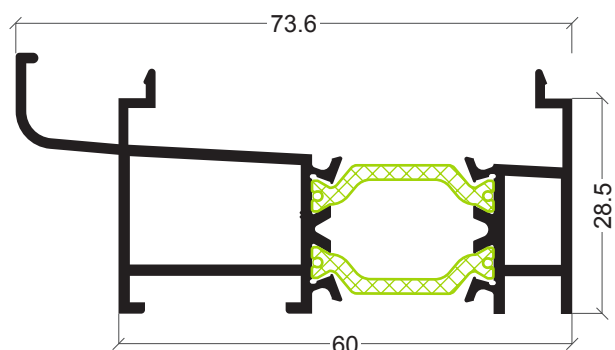

CT-11
Soleira condensação

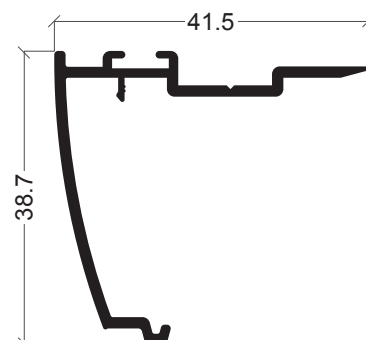

CT-06
Tampa cruzamento aro móvel

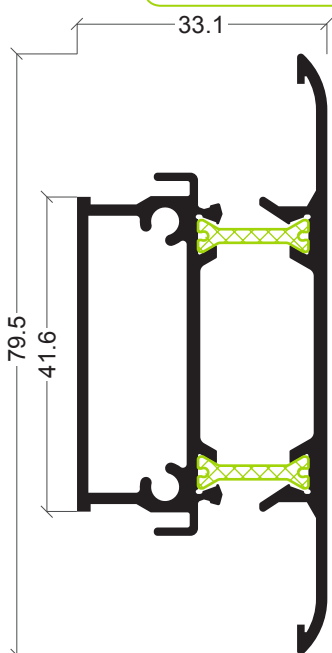

CT-04
Travessa com bite

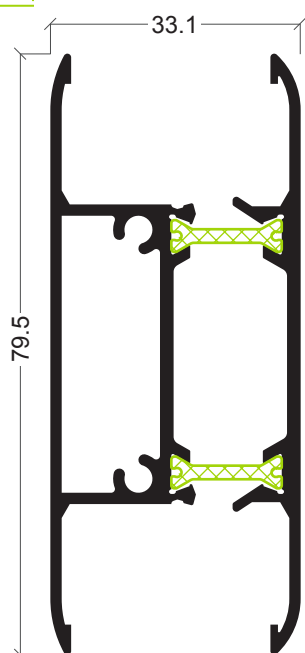

CT-13
Travessa sem bite

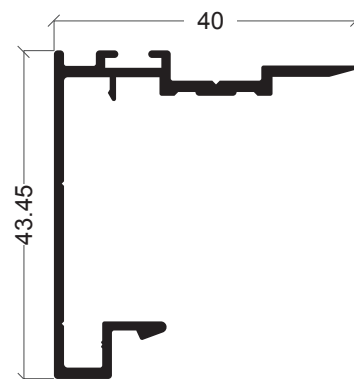

CT-54
Tampa cruzamento aro móvel recto

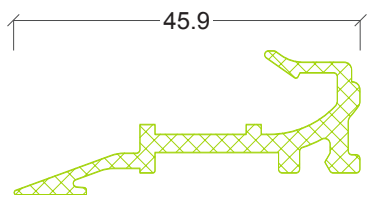

CT-08

Cruzamento móvel

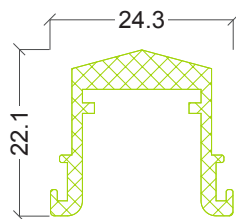

CT-10

União 3/4 folhas CT-02/12

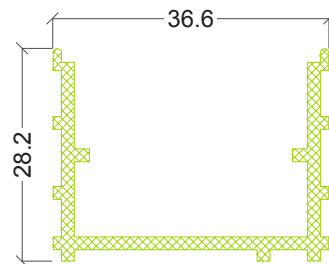

CT-09

Tampa aro fixo perimetral

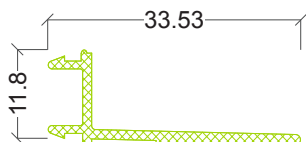

CT-23

Tampa aro fixo perimetral

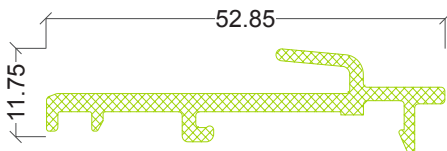

CT-26

Cruzamento móvel

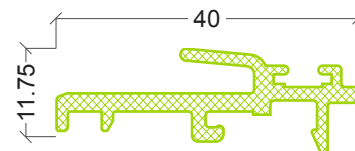

CT-25

Cruzamento móvel

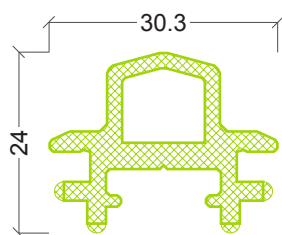

CT-24

União 3/4 folhas CT-35/53

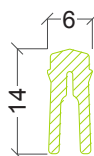

CT-71

Guia carril (poliamida)

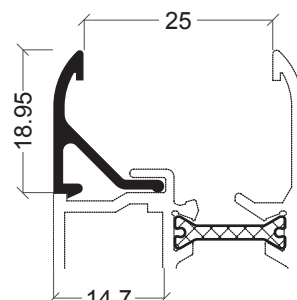

CT-05

Bite

285

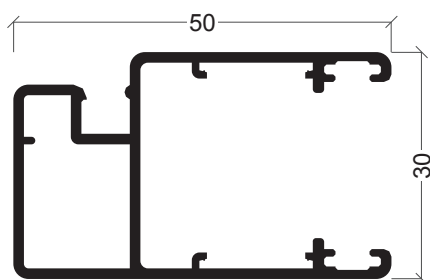

CT-73

Perfil para rede mosquiteira

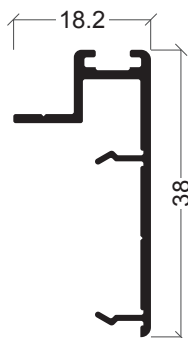

CT-74

Tampa

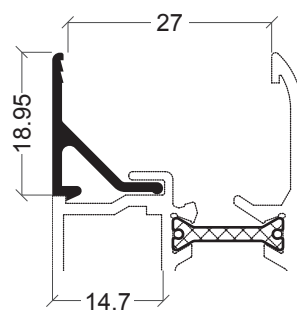

CT-40

Bite

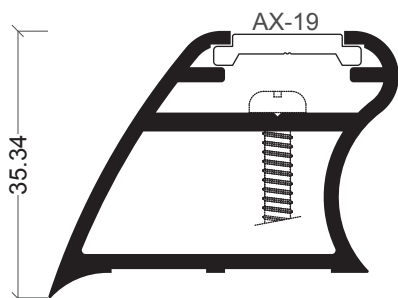

CT-03

Reforço

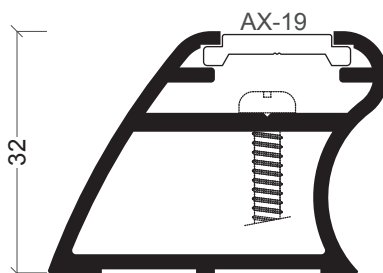

CT-27

Reforço

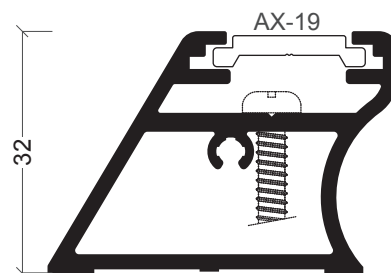

CT-28

Reforço

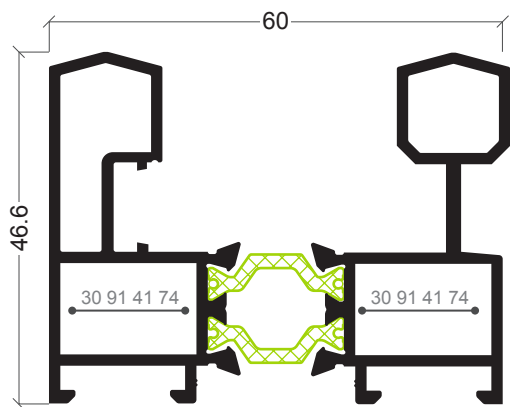

CT-41
Aro fixo perimetral

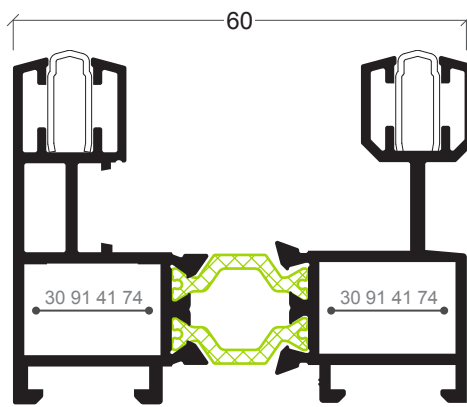

CT-42
Aro fixo perimetral

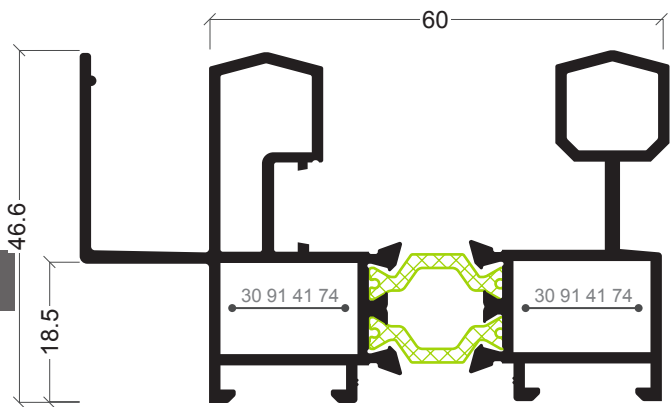

CT-43
Aro fixo perimetral

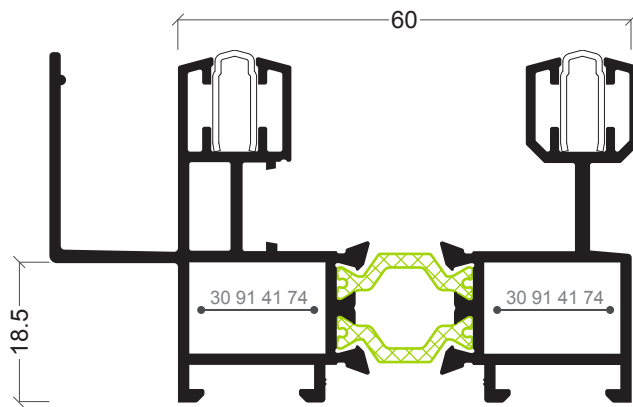

CT-44
Aro fixo perimetral

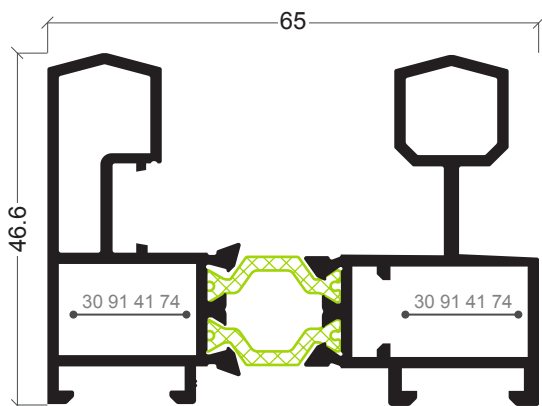

CT-45
Aro fixo perimetral

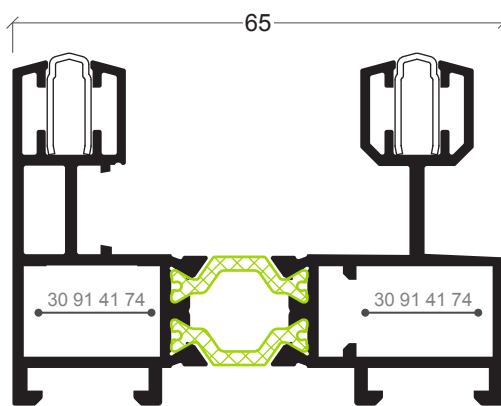

CT-46
Aro fixo perimetral

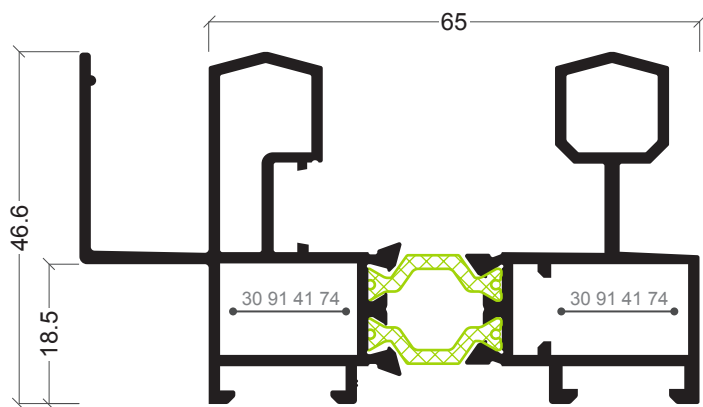

CT-47
Aro fixo perimetral

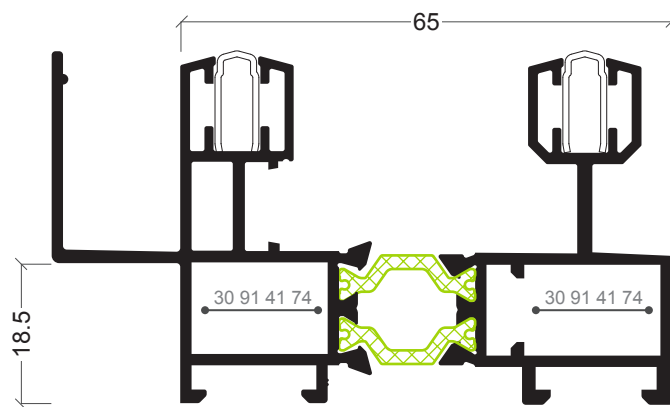

CT-48
Aro fixo perimetral

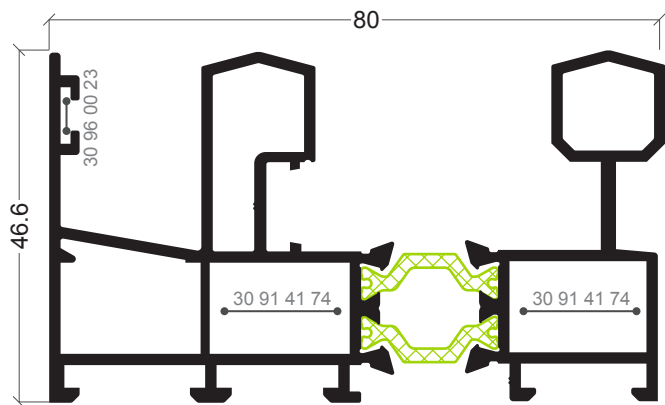

CT-49
Aro fixo perimetral

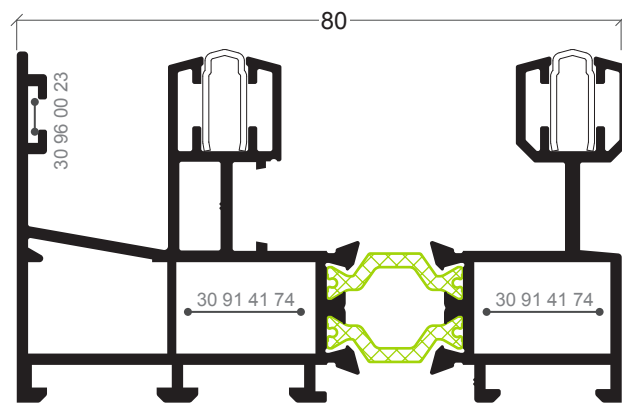

CT-50
Aro fixo perimetral

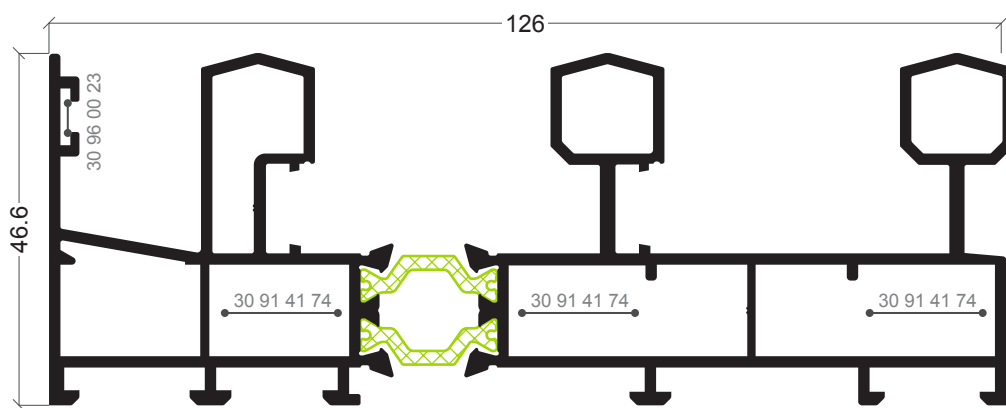

CT-51
Aro fixo perimetral tri-rail

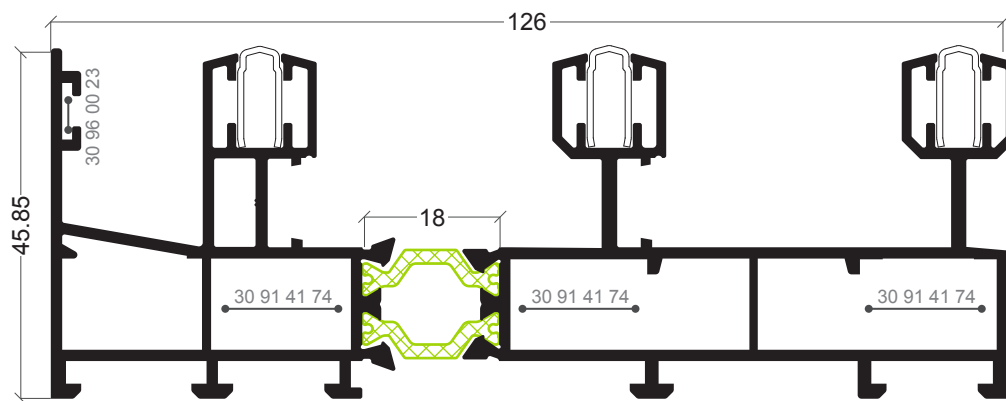

CT-52
Aro fixo perimetral tri-rail

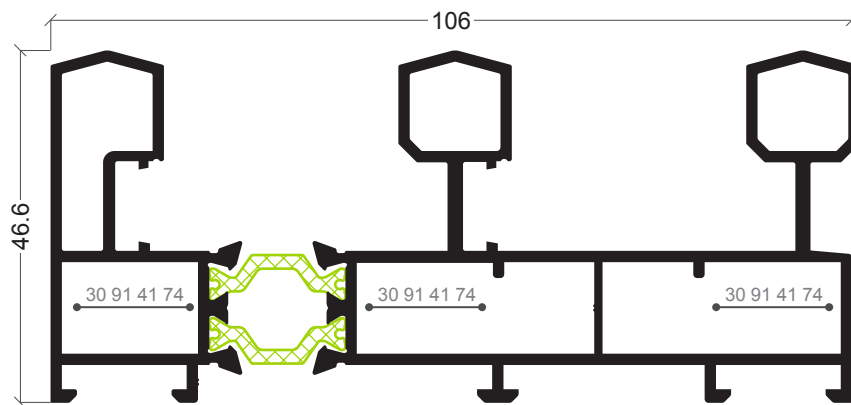

CT-55
Aro fixo perimetral tri-rail

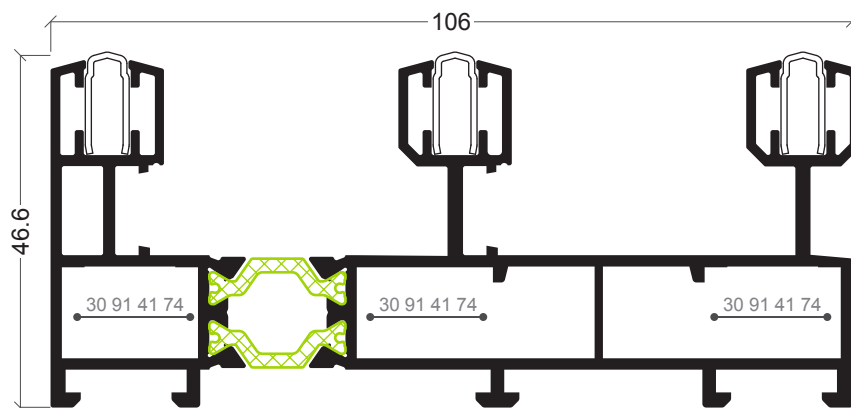

CT-56
Aro fixo perimetral tri-rail

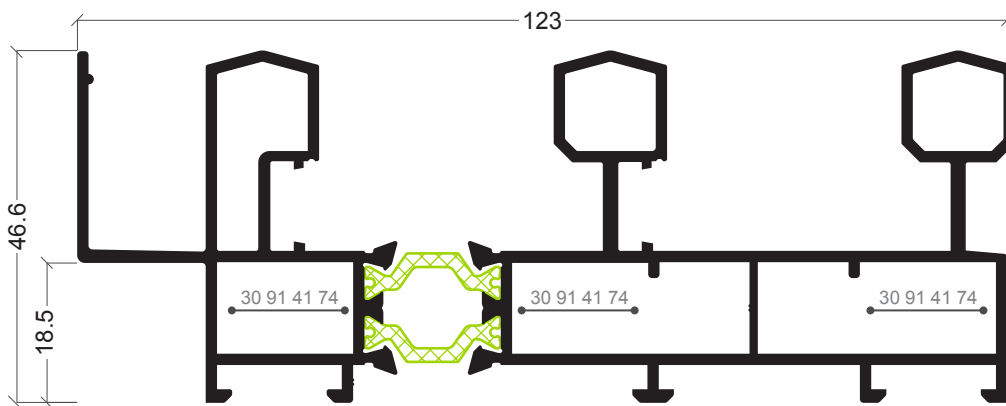

CT-57
Aro fixo perimetral tri-rail

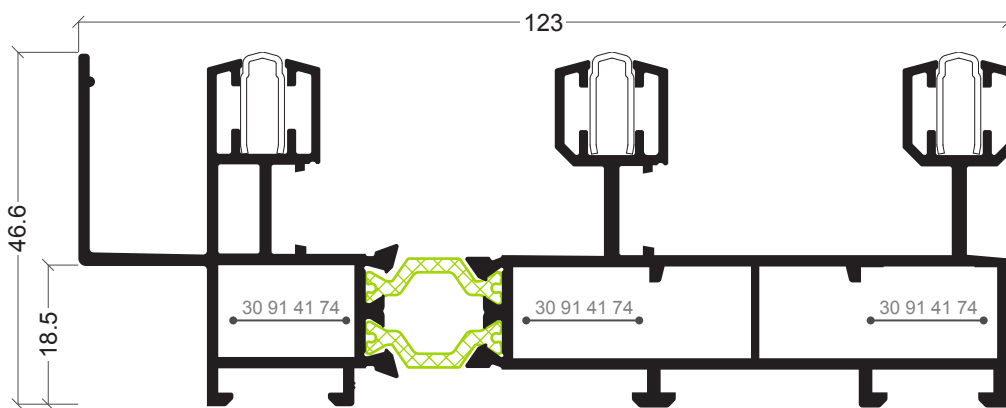

CT-58
Aro fixo perimetral tri-rail

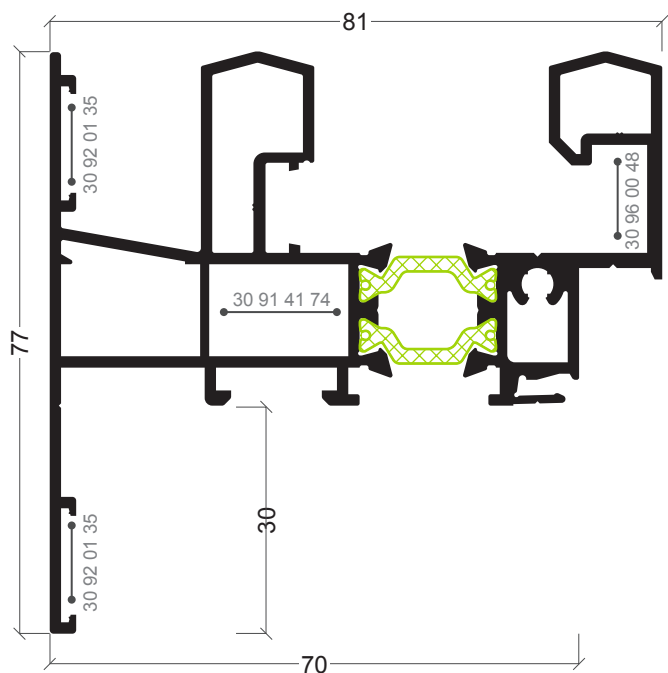

CT-61
Aro fixo perimetral c/ aba remate

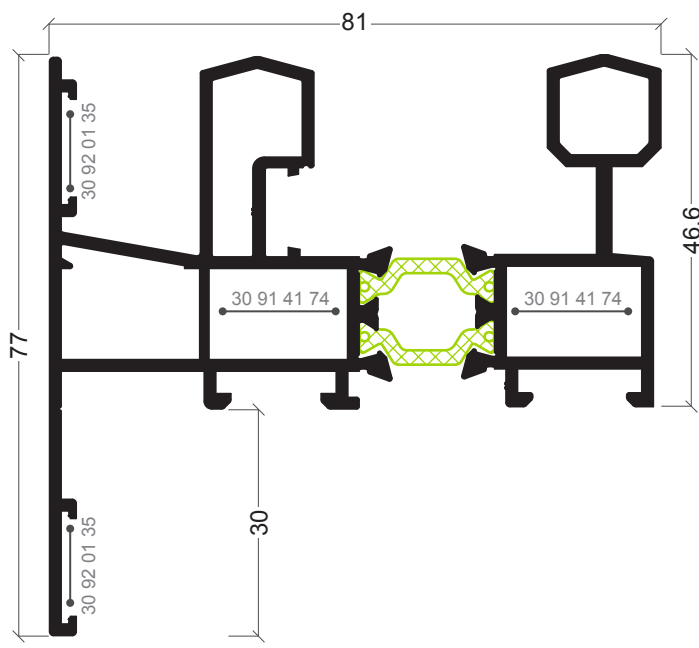

CT-62
Aro fixo perimetral c/ aba remate

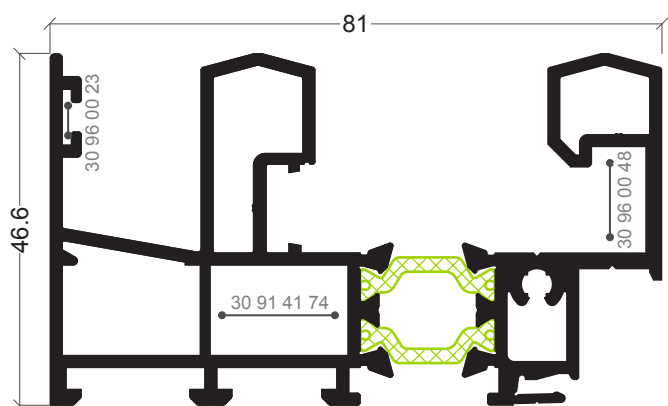

CT-63
Aro fixo perimetral

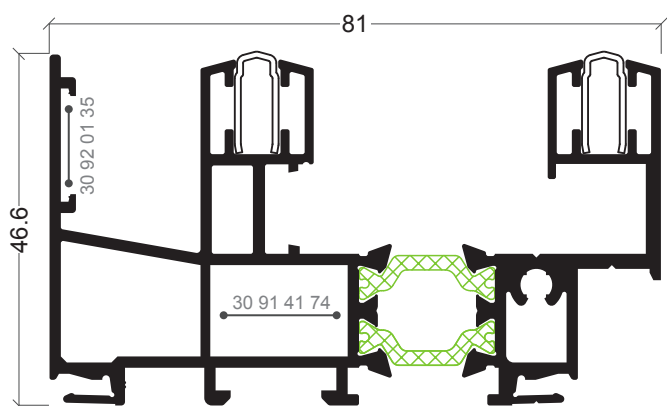

CT-69
Aro fixo perimetral

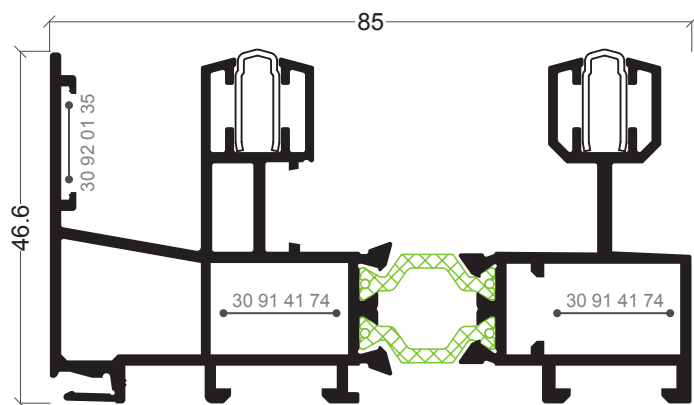

CT-72
Aro fixo perimetral

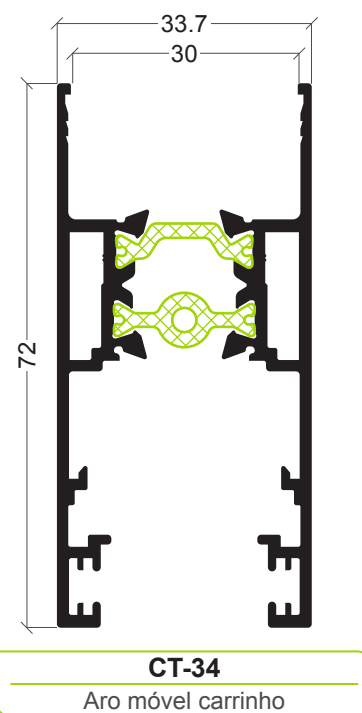
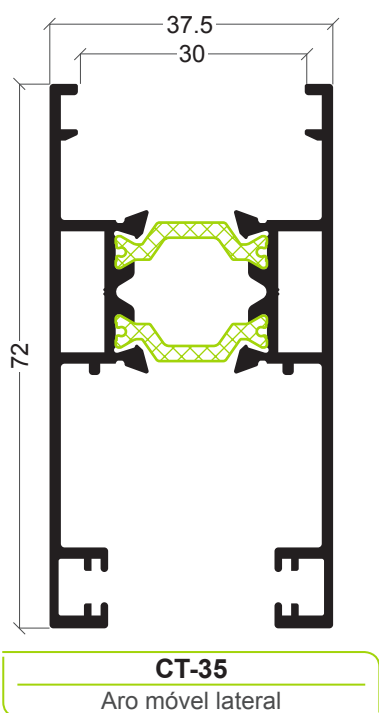
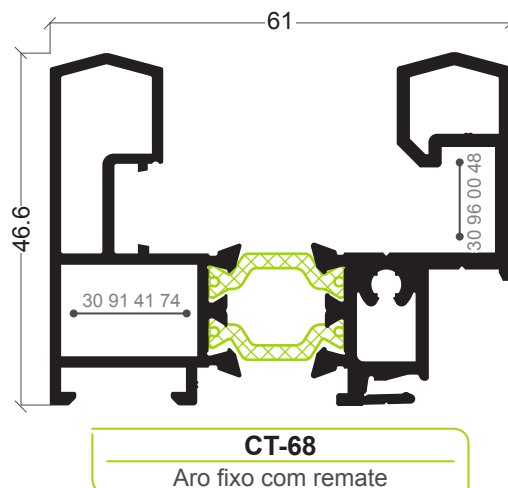
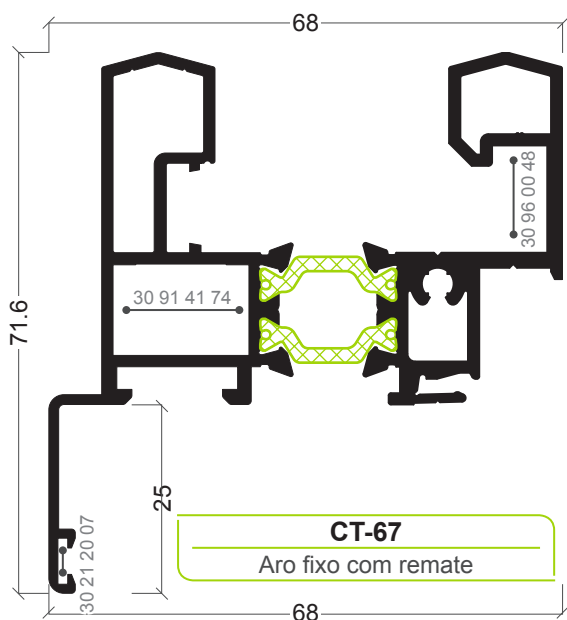
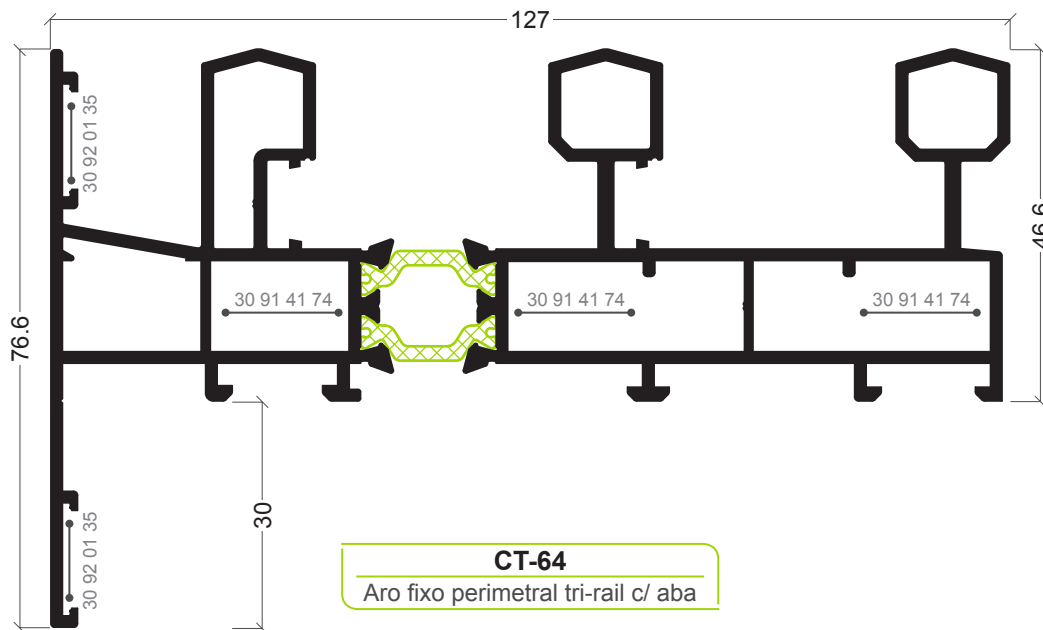

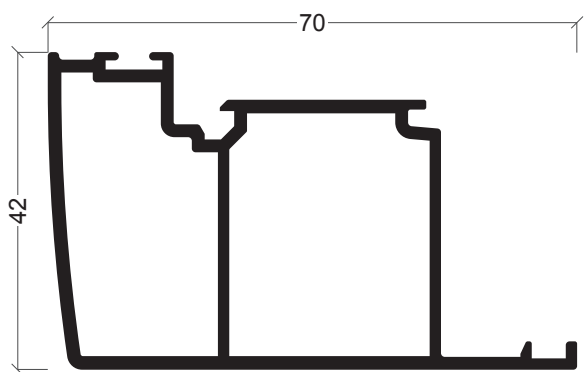

CT-37
Aro móvel central

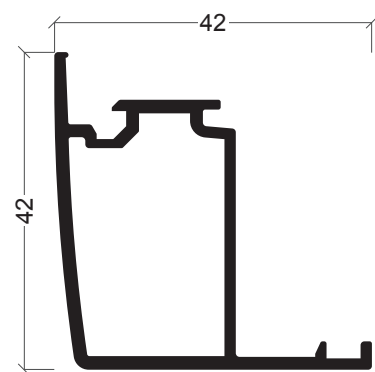

CT-36
Aro móvel central

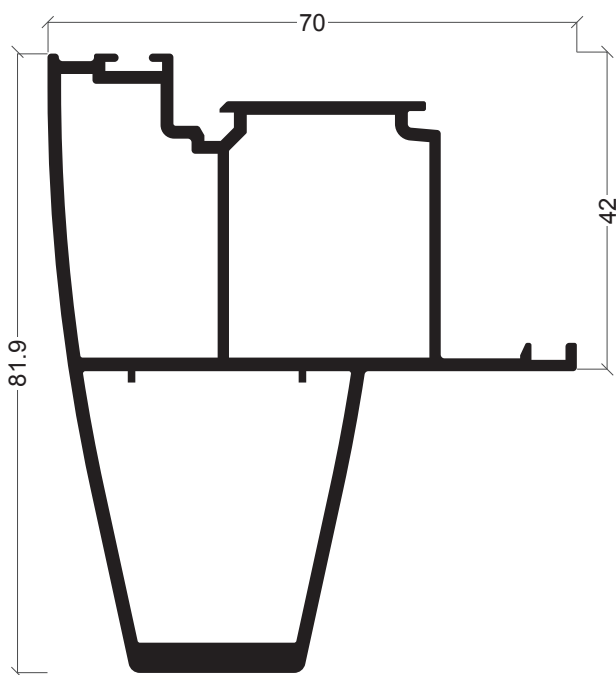

CT-39
Aro móvel central com reforço

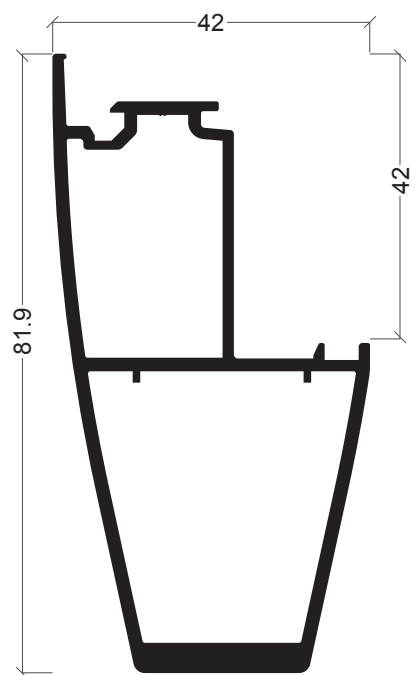

CT-38
Aro móvel central com reforço

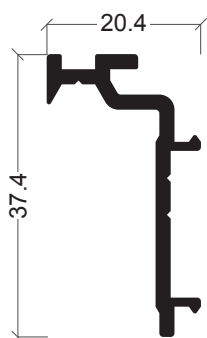

ARI-26
Mola tapa juntas

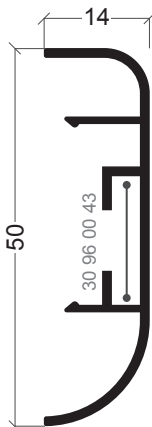

ARI-27
Tapa juntas

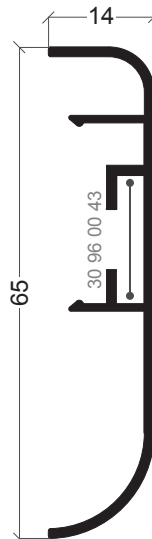

ARI-34
Tapa juntas

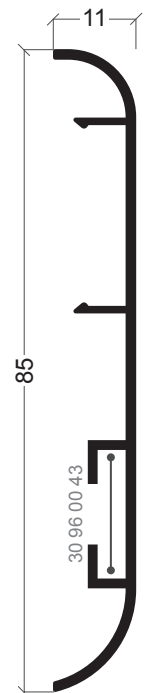

ARI-28
Tapa juntas

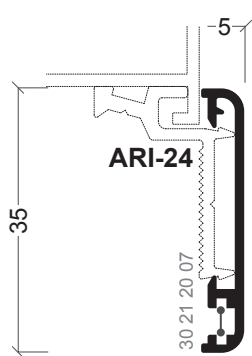

ARI-30
Tapa juntas

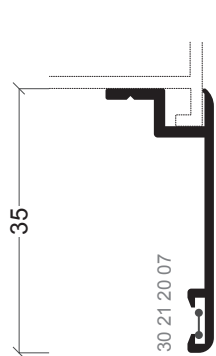

ARI-31
Tapa juntas

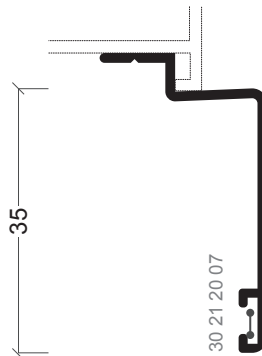

ARI-37
Tapa juntas

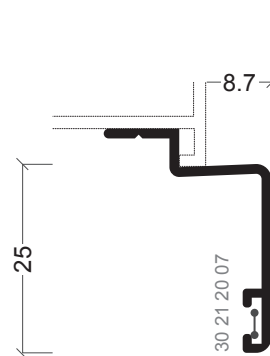

ARI-66
Tapa juntas

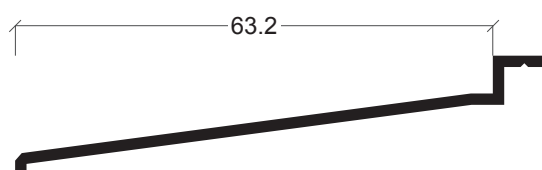

AZ-23
Pingadeira 60 mm

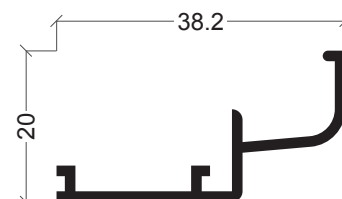

ARI-32
Complemento condensação

292

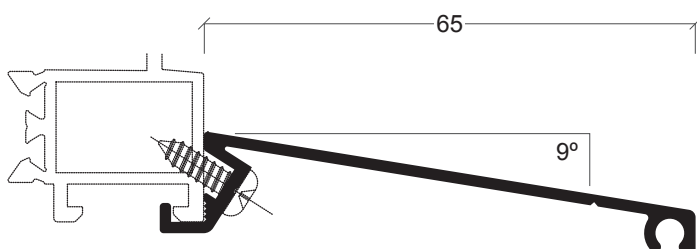

CT-30
Pingadeira 65 mm



CT-33
Guia carril (aço inox 304)

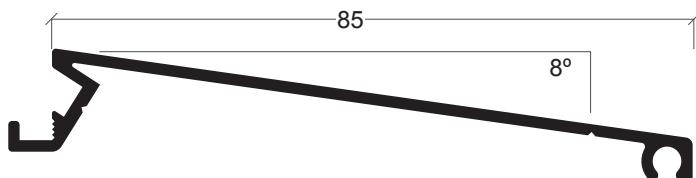

CT-31
Pingadeira 85 mm

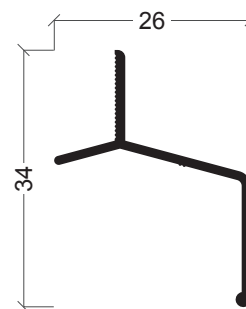

CT-07
Pingadeira superior

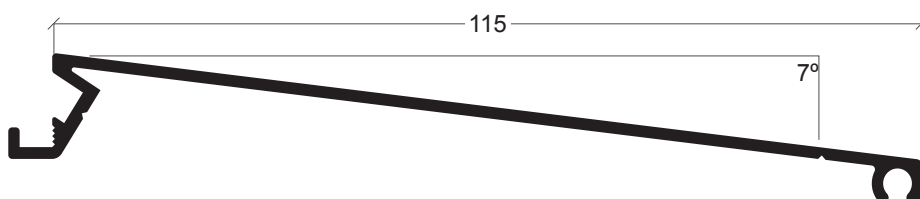

CT-32
Pingadeira 115 mm

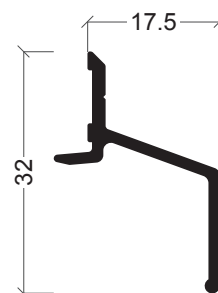

CT-29
Pingadeira superior

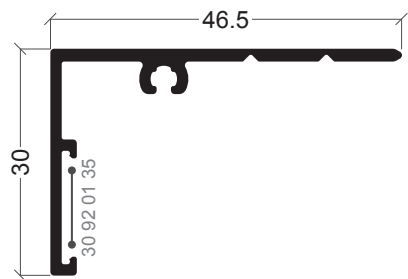

AXi-80
Remate

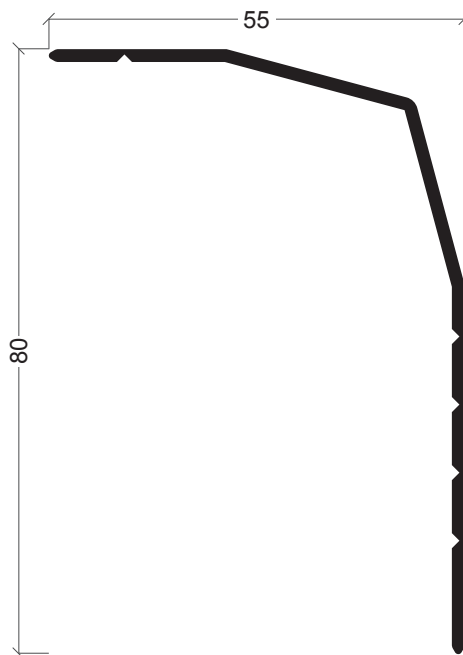

AXi-72
Remate

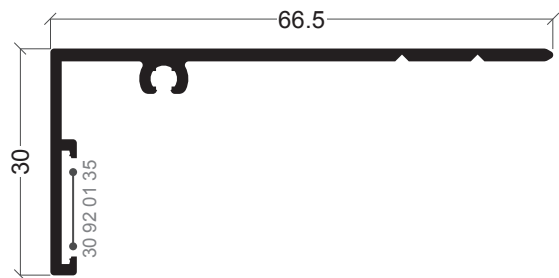

AXi-73
Remate

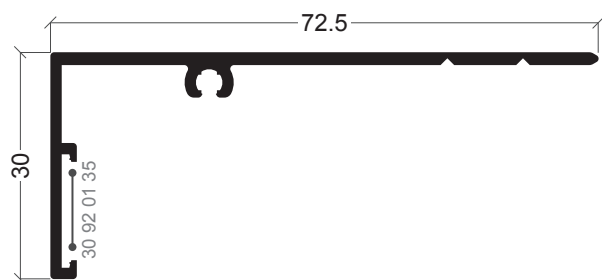

AXi-83
Remate

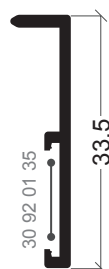

AXi-88
Remate



AXi-91
Complemento remate

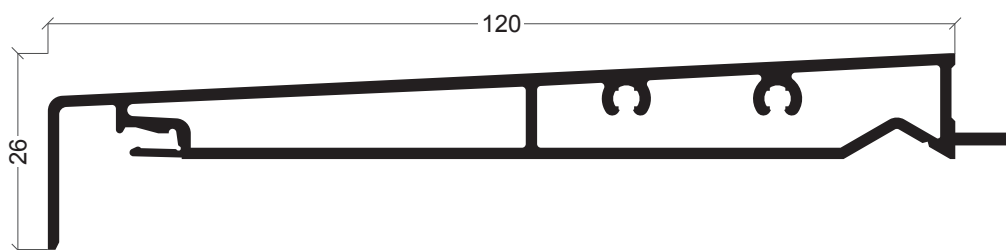

AXi-74
Pingadeira de 120 mm

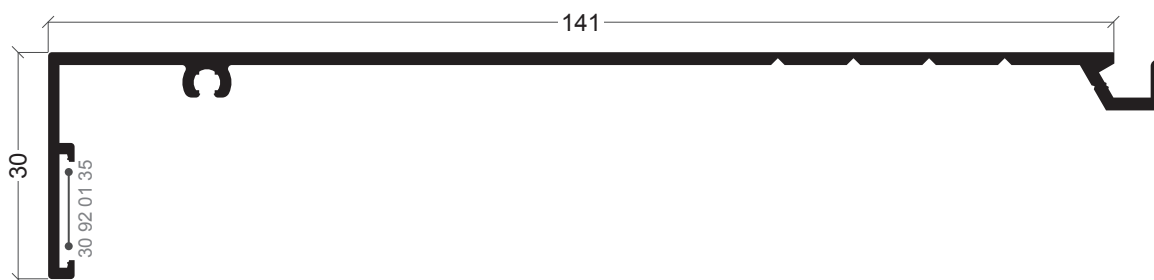

S-09
Remate

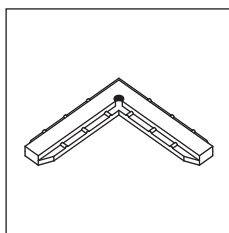

30 21 20 07

Esquadro de alinhamento

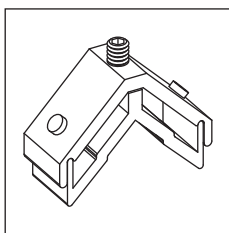

30 91 40 15

Esquadro aro fixo

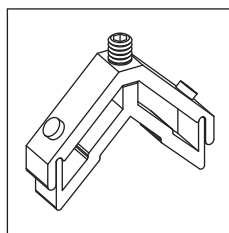

30 91 40 25

Esquadro aro móvel

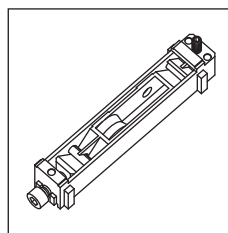

30 91 40 35

Rolamento simples (25Kg)

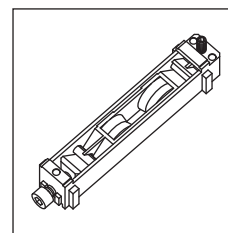

30 91 40 36

Rolamento simples (50Kg)

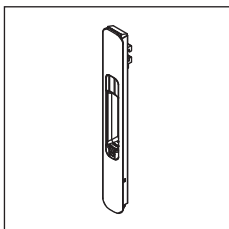

30 91 40 39/40/41

Fecho lateral manual natural/branco/preto

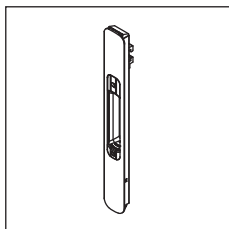

30 91 40 42/43

Fecho lateral de embutir branco/preto

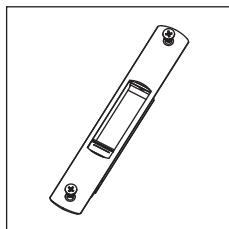

30 91 40 45/46

Fecho lateral com fixação branco/preto

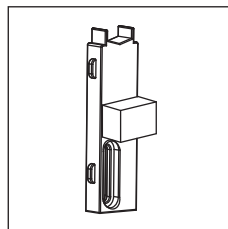

30 91 40 50

Guia lateral batente

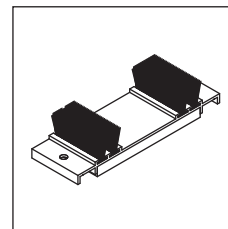

30 91 40 70

Corta-vento superior/inferior

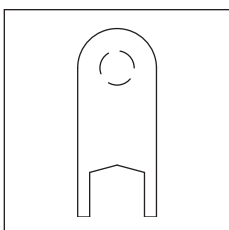

30 91 41 00

Tampa aro móvel recta

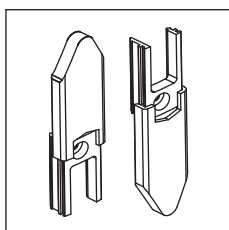

30 91 41 05

Jogo topos laterais

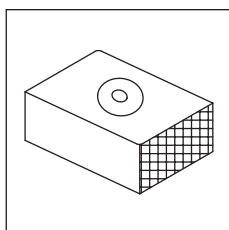

30 91 41 10

Taco anti-levantamento preto

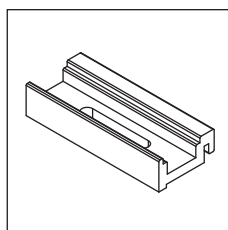

30 91 41 20

Calço nº 1 para multi-ponto CT-02/12/53

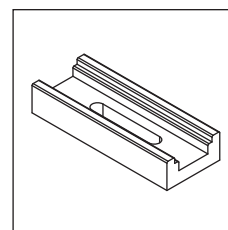

30 91 41 21

Calço nº 2 para multi-ponto CT-35

294

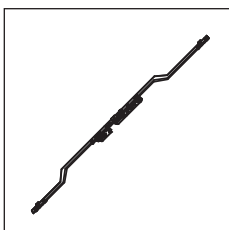

30 91 41 22

Ferragem MP c/ chave sem canhão

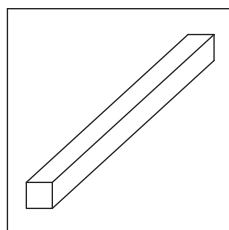

30 91 41 23

Perno 7x131 mm

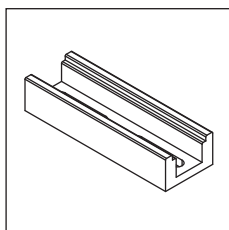

30 91 41 24

Calço nº 3 para multi-ponto inox

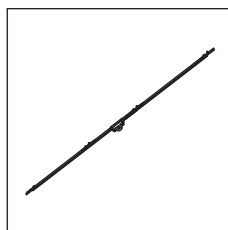

30 91 41 29

Barra 4 pontos (1800 mm)

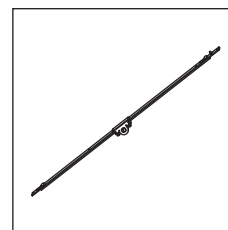

30 91 41 30

Barra 2 pontos (600 mm)

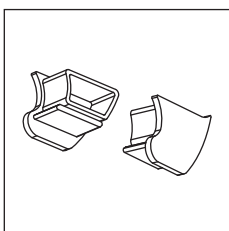

30 91 41 35

Jogo topos CT-03

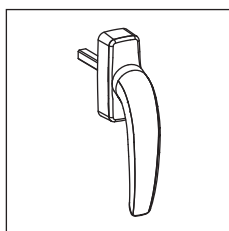

30 91 41 47/48

Cremone multi-ponto branco/preto

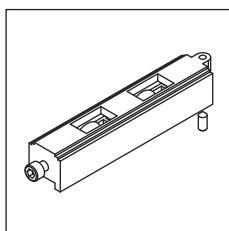

30 91 41 49

Rolamento duplo (75 kg)

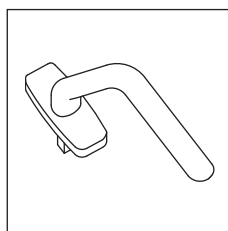

30 91 41 52/53

Cremone desviado direita branco/preto

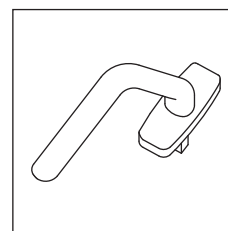

30 91 41 54/55

Cremone desviado esquerda branco/preto

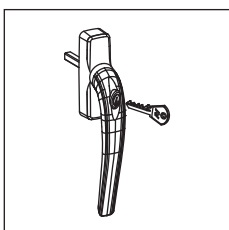

30 91 41 56/57

Cremone porta com chave branco/preto

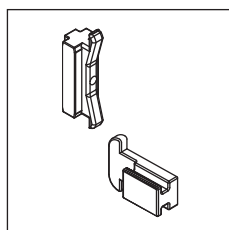

30 91 41 60

Ponto de fecho para carris abertos

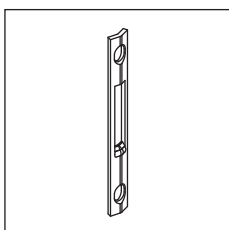

30 91 41 61

Ponto de fecho plano (para ferragem inox)

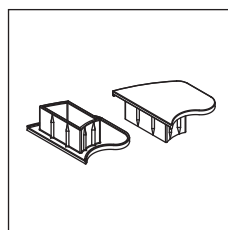

30 91 41 63/64

Jogo topos CT-27 branco/preto

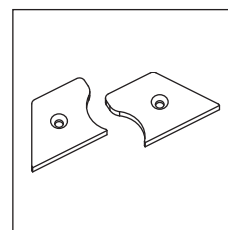

30 91 41 65/66

Jogo topos CT-28 branco/preto

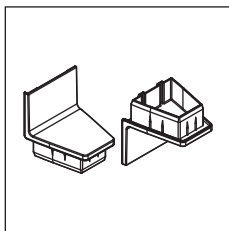

30 91 41 67/68

Jogo topos centrais
(branco/preto)

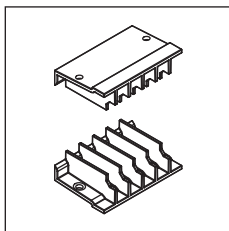

30 91 41 69

Corta ventos aro fixo
Benelux (CT-36/38)

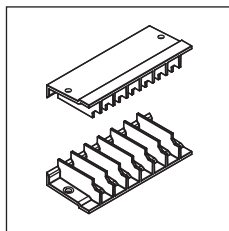

30 91 41 70

Corta ventos aro fixo Benelux
(CT-02/12/37/39/53)

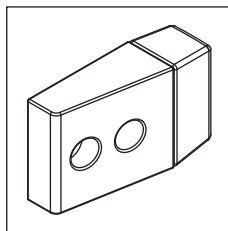

30 91 41 71

Topo limitador de
abertura

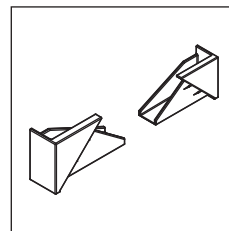

30 91 41 72/73

Jogo topos aro
condensação branco/preto

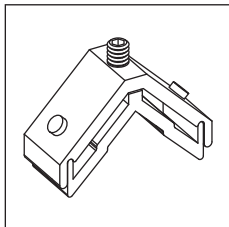

30 91 41 74

Esquadro aro fixo
perimetral Benelux

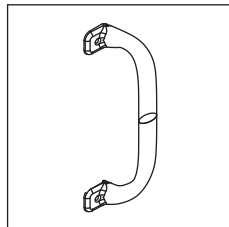

30 91 41 77/78

Puxador p/ fecho embutir
(branco/preto)

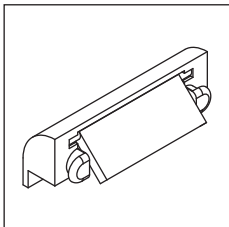

30 92 01 02/03

Goteira nylon c/ válvula
preto / branco

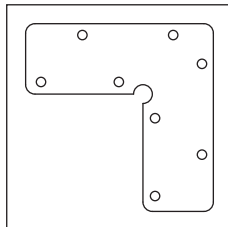

30 92 01 35

Esquadro alinhamento

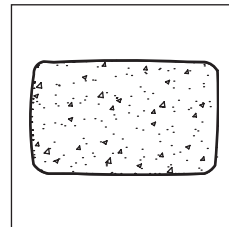

30 92 04 70

Espuma isolante

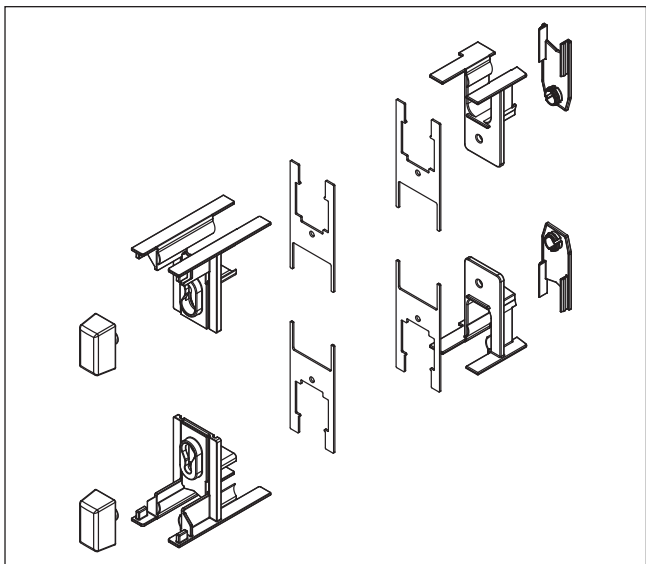

30 91 41 81

Kit topos de janela folhas
laterais Benelux (1 folha)

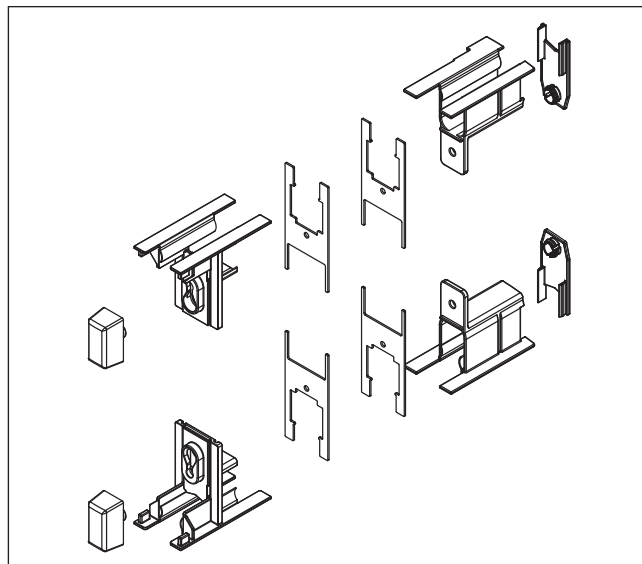

30 91 41 82

Kit topos de porta folhas
laterais Benelux (1 folha)

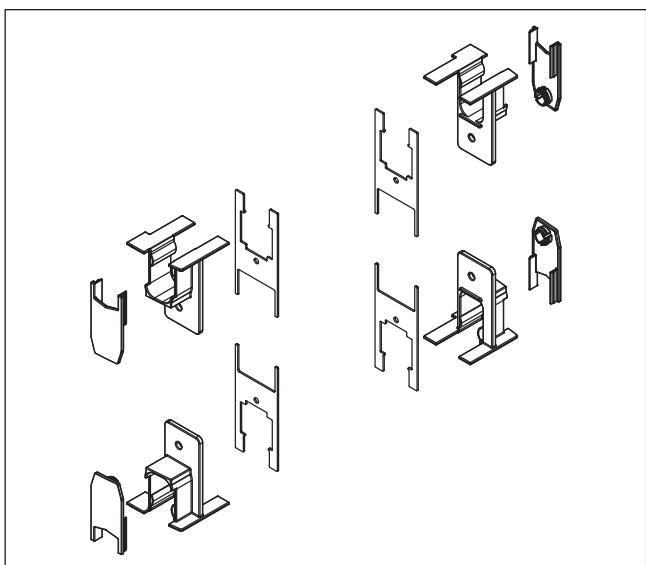

30 91 41 83

Kit topos de janela folha
central Benelux (3ª folha)

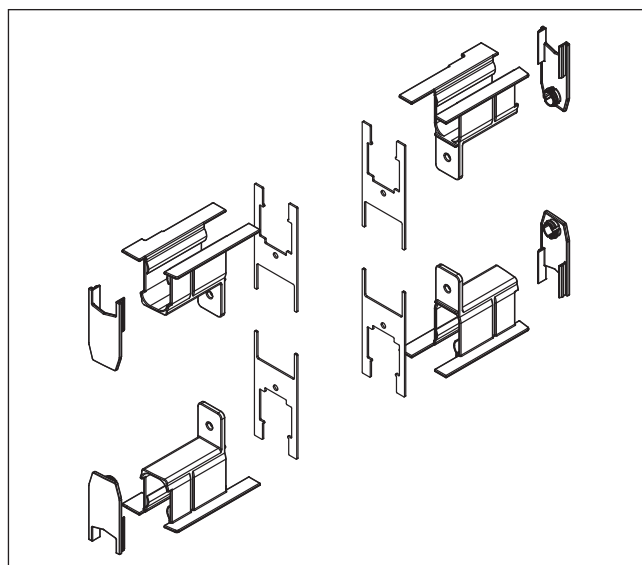

30 91 41 84

Kit topos de porta folha
central Benelux (3ª folha)

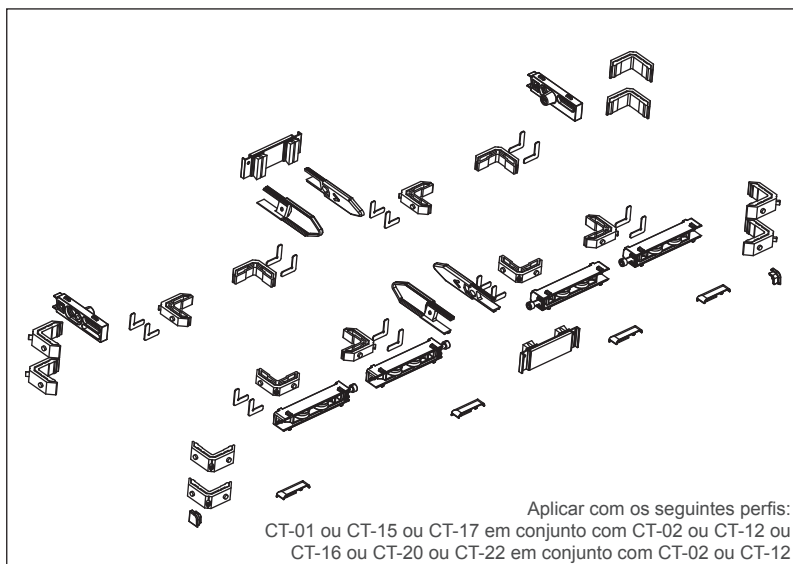

Aplicar com os seguintes perfis:
CT-01 ou CT-15 ou CT-17 em conjunto com CT-02 ou CT-12 ou
CT-16 ou CT-20 ou CT-22 em conjunto com CT-02 ou CT-12

30 91 41 85

Kit de correr janela CT (2 folhas). Resistência até 50Kg/folha. Utilização vãos de 2 folhas.

30 91 41 86

Kit de correr porta CT (2 folhas). Resistência até 100Kg/folha. Utilização vãos de 2 folhas.

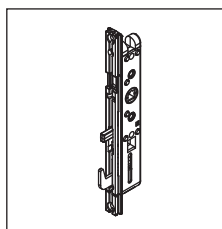

30 92 07 30

Ferragem MP regulável inox 1 ponto CT-35



30 92 07 35

Ferragem MP regulável inox 2 pontos CT-35



30 92 07 40

Ferragem MP regulável inox 3 pontos CT-35



30 92 07 45

Ferragem MP regulável inox 3 pontos com chave CT-35

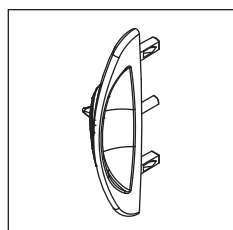

30 92 07 50/55

Puxador calipso interior branco/preto (p/ ferragem inox)

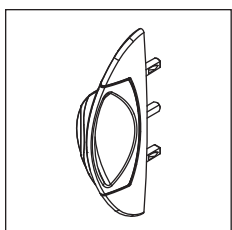

30 92 07 60/65

Puxador neptune interior branco/preto (p/ ferragem inox)

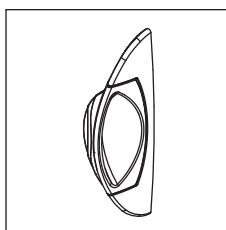

30 92 07 70/75

Puxador neptune exterior branco/preto (p/ ferragem inox)

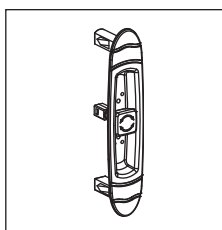

30 92 07 80/85

Fecho lateral hera branco/preto (p/ ferragem inox)

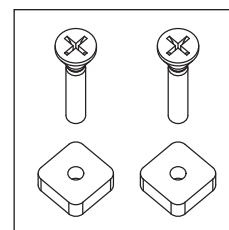

30 92 07 96

Placas para pontos de fecho multiponto com carris abertos

296

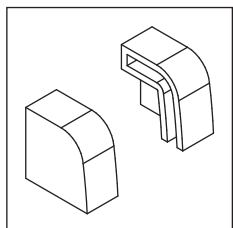

30 96 00 12

Jogo topos condensação CT-11/ARI-32

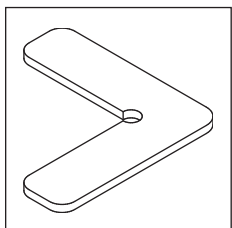

30 96 00 23

Esquadro alinhamento

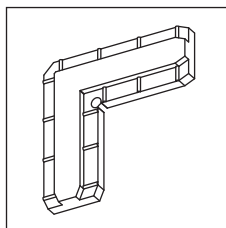

30 96 00 43

Esquadro de alinhamento 004

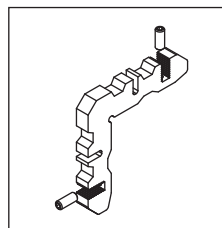

30 96 00 48

Esquadro de alinhamento 7x14 c/ parafusos

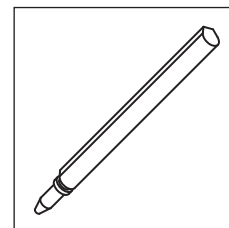

30 96 00 55

Perno alternativo para fixação de esquadro

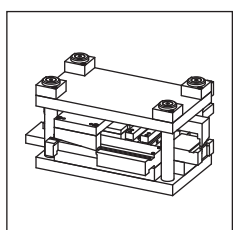

33 94 29 99

Cunho CT

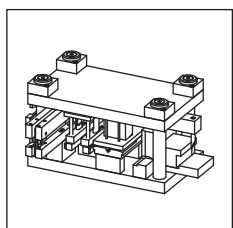

33 94 30 00

Cunho CT Benelux

Referência	Desenho	Descrição
30 20 30 03		Junta isolante CT-01/11/15/17
30 25 44 15		Junta tapa canal
30 91 41 87		Junta tapa carril aberto
30 91 41 88		Junta de correr
30 93 00 65		Junta interior para vidro (5 mm)
30 93 00 66		Junta interior para vidro (4 mm)
30 93 00 67		Junta interior para vidro (2 mm)
30 93 00 68		Junta interior para vidro (6/7 mm)
30 93 00 69		Junta interior para vidro (8/9 mm)
30 95 00 40		Pelúcia 7x5.5 mm
30 95 00 50		Pelúcia 7x6 mm
30 95 00 70		Pelúcia 7x3.5 mm

Janela 2 folhas correr

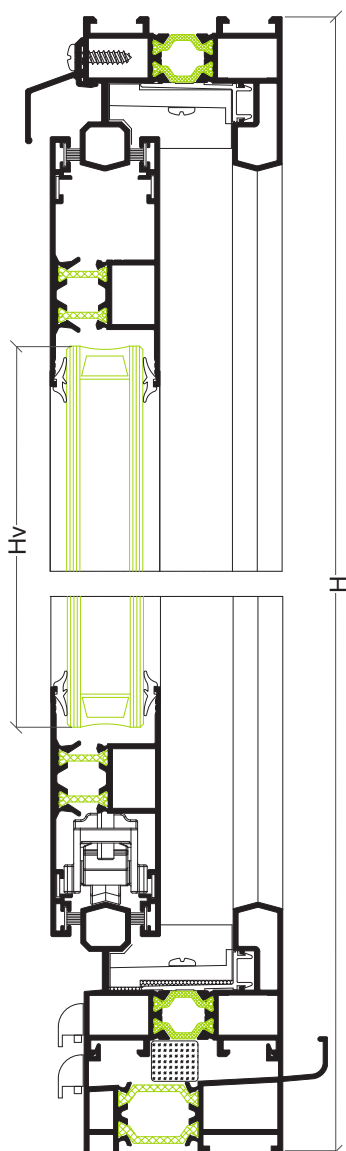
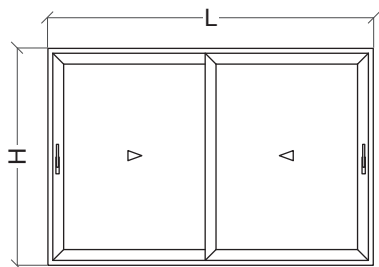

Perfis

Desenho	Ref	Descrição	Corte	Quant	Medida
	CT-41	Aro fixo perimetral		2	L
				2	H-28.5 mm
	CT-23	Tampa aro fixo		2	L-40 mm
				2	H-68 mm
	CT-53	Aro móvel perimetral		4	L/2+1 mm
				4	H-101.5 mm
	CT-54	Tampa cruzamento 2 folhas		2	H-101.5 mm
	CT-29	Pingadeira superior		1	L
	CT-08	União cruzamento 2 folhas		2	H-101.5 mm
	CT-11	Soleira de condensação		1	L

Acessórios e Juntas

Referência	Descrição	Quantidade
30 91 41 74	Esquadro aro fixo	8
30 91 40 25	Esquadro aro móvel	8
30 91 40 35	Rolamento simples	4
30 91 40 42	Fecho lateral	2
30 91 40 50	Guia lateral	4
30 91 40 70	Corta-ventos inferior/superior	1
30 91 41 00	Tampa móvel recta	4
30 92 01 02	Goteiras	4
30 96 00 12	Jogo topos condensação	1
30 96 00 23	Esquadro alinhamento	16
30 91 41 10	Taco anti-levantamento	2
30 92 04 70	Espuma isolante	L
----	Junta vidro	4L+8H
30 95 00 40*	Pelúcia 7x5.5 mm	4L+6H

* junta alternativa ref.: 30 91 41 88

Vidro

Hv = H-200 mm	Lv = L/2-126 mm
---------------	-----------------

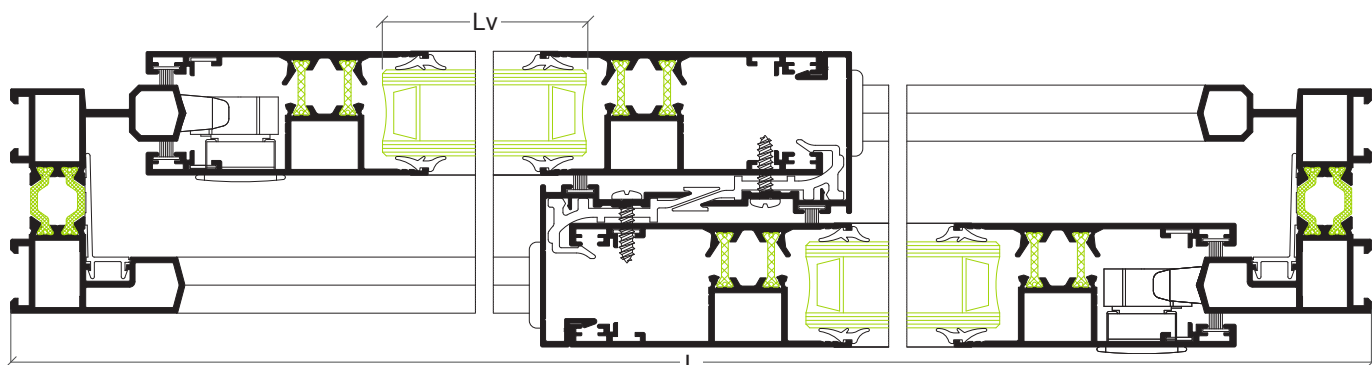

Janela 2 folhas correr

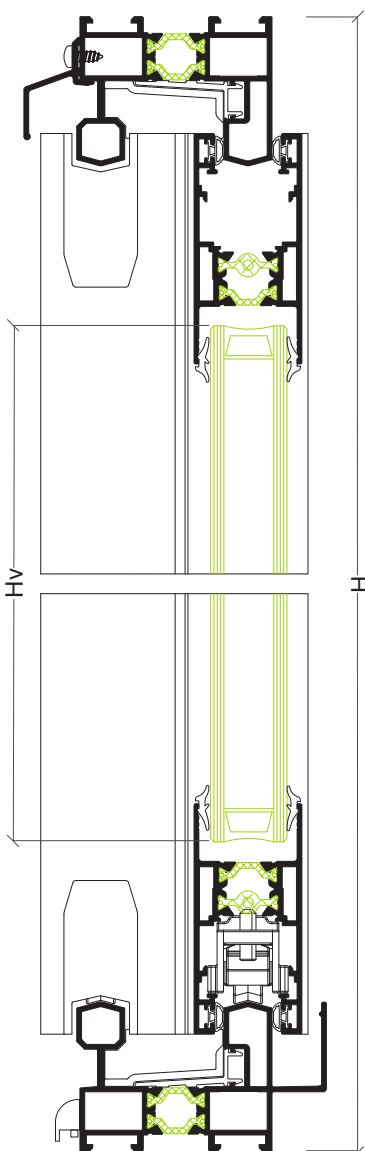
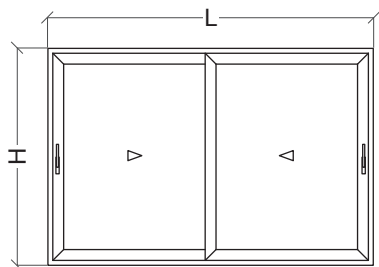

Perfis

Desenho	Ref	Descrição	Corte	Quant	Medida
	CT-41	Aro fixo perimetral		1	L
				2	H
	CT-43	Aro fixo perimetral condensação		1	L
	CT-23	Tampa aro fixo		2	L-40 mm
				2	H-40 mm
	CT-34	Aro móvel carrinho		4	L/2-93 mm
	CT-35	Aro móvel lateral		2	H-73 mm
	CT-36	Aro móvel central		2	H-73 mm
	CT-25	Cruzamento móvel		2	H-73 mm
	CT-29	Pingadeira superior		1	L

Acessórios e Juntas

Referência	Descrição	Quantidade
30 91 41 74	Esquadro aro fixo	8
30 91 40 35	Rolamento simples	4
30 91 40 42	Fecho lateral	2
30 91 41 69	Jogo corta-ventos superior/inferior	1
30 91 41 81	Kit topos janela	2
30 92 01 02	Goteiras	2
30 91 41 73	Jogo topos condensação	1
30 91 41 10	Taco anti-levantamento	2
30 91 41 88*	Junta de correr	4L+6H

* pelúcia alternativa ref.: 30 95 00 40

Vidro



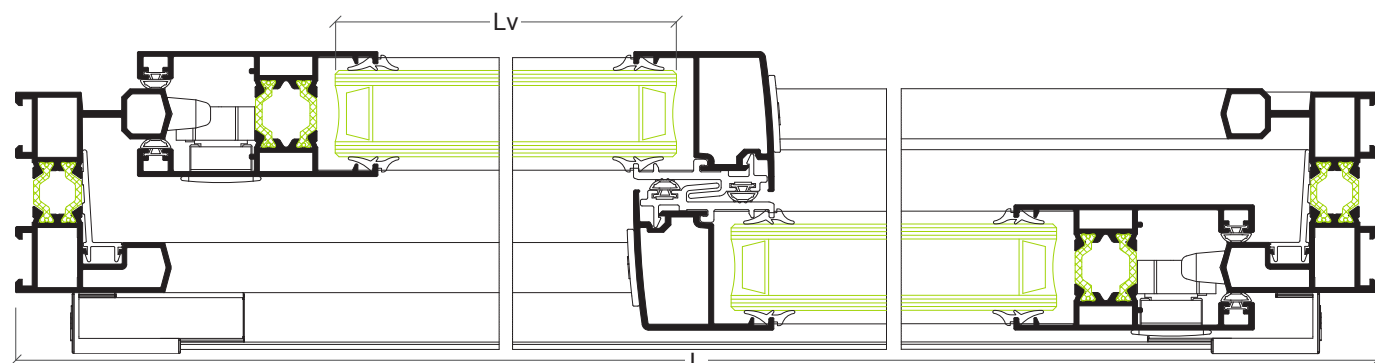



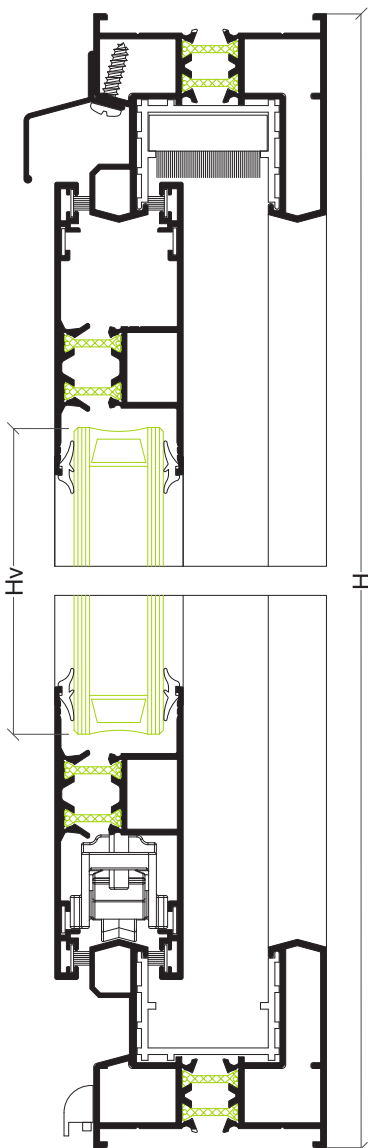
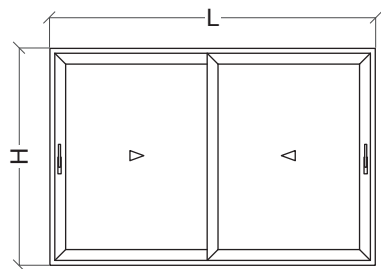









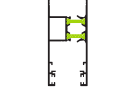

Hv = H-192 mm	Lv = L/2-103 mm
---------------	-----------------

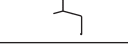

Porta 2 folhas correr multiponto



Perfis

Desenho	Ref	Descrição	Corte	Quant	Medida
	CT-01	Aro fixo perimetral		2	L
				2	H
	CT-09	Tampa aro fixo		2	L-45 mm
				2	H-45 mm
	CT-53	Aro móvel perimetral		4	L/2-7 mm
				4	H-87 mm
	CT-54	Tampa cruzamento 2 folhas		2	H-87 mm
	CT-07	Pingadeira superior		1	L
	CT-08	União cruzamento 2 folhas		2	H-87 mm
	CT-28	Perfil de reforço		1	H-170 mm
	AX-19	Complementar para perfil de reforço		1	H-170 mm

Acessórios e Juntas

Referência	Descrição	Quantidade
30 91 40 15	Esquadro aro fixo	8
30 91 40 25	Esquadro aro móvel	8
30 91 41 49	Rolamento duplo reforçado	4
----	Ferragem multiponto (600 ou 1800 mm)	2
30 91 41 47	Cremona multiponto	2
30 91 41 20	Calço nº 1 para multiponto	8 ou 16
30 91 41 71	Limitador de abertura	1
30 91 40 50	Guia lateral	4
30 91 40 70	Corta ventos inferior/superior	2
30 91 41 00	Tampa móvel recta	4
30 92 01 02	Goteiras	2
30 96 00 23	Esquadro alinhamento	16
30 91 41 66	Jogo topos CT-28	2
----	Junta vidro	4L+8H
30 95 00 40'	Pelúcia 7x5.5 mm	4L+6H

* junta alternativa ref.: 30 91 41 88

Vidro

Hv = H-214 mm	Lv = L/2-134 mm
---------------	-----------------

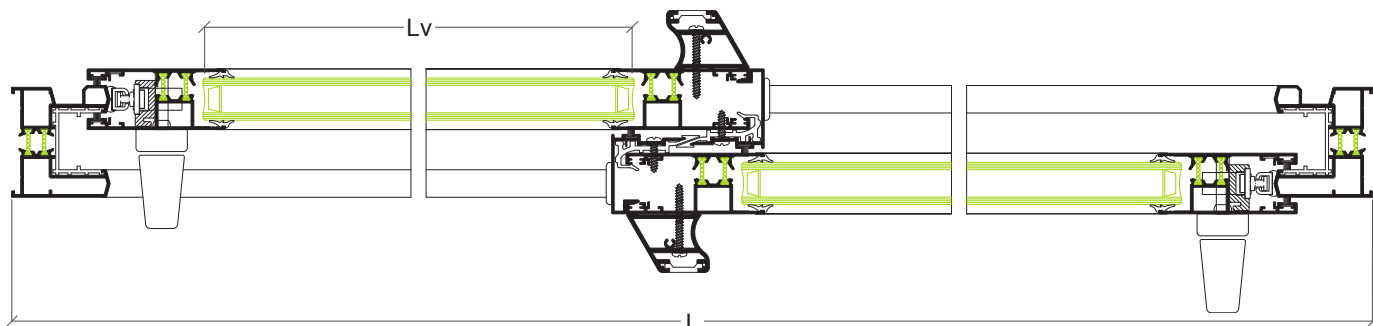

Porta 2 folhas correr multiponto

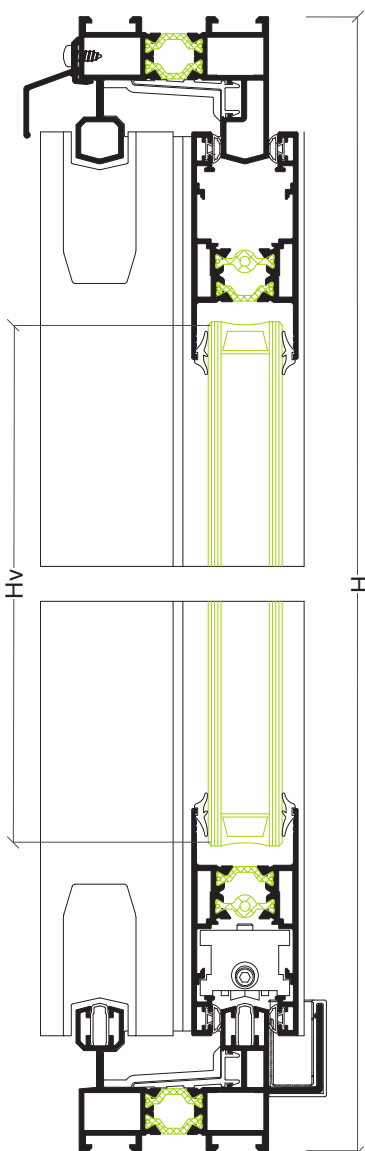
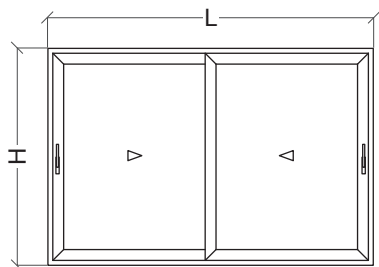

Perfis

Desenho	Ref	Descrição	Corte	Quant	Medida
	CT-41	Aro fixo perimetral		1	L
				2	H
	CT-44	Aro fixo perimetral condensação		1	L
	CT-33	Guia carril		2	L-93 mm
	CT-23	Tampa aro fixo		2	L-40 mm
				2	H-40 mm
	CT-34	Aro móvel carrinho		4	L/2-107 mm
	CT-35	Aro móvel lateral		2	H-73 mm
	CT-37	Aro móvel central		1	H-73 mm
	CT-39	Aro móvel central com reforço		1	H-73 mm
	CT-26	Cruzamento móvel		2	H-73 mm
	CT-29	Pingadeira superior		1	L

Acessórios e Juntas

Referência	Descrição	Quantidade
30 91 41 74	Esquadro aro fixo	8
30 91 41 49	Rolamento duplo reforçado	4
----	Ferragem multiponto (600 ou 1800 mm)	2
30 91 41 47	Cremona multiponto	2
30 91 41 21	Calço nº 2 para multiponto	8 ou 16
30 91 41 71	Limitador de abertura	1
30 91 41 70	Jogo corta-ventos superior/inferior	1
30 91 41 82	Kit topos porta	2
30 92 01 00	Goteiras	2
30 91 41 73	Jogo topos condensação	1
30 91 41 67	Jogo topo central	1
30 91 41 88*	Junta de correr	4L+6H

* pelúcia alternativa ref.: 30 95 00 40

Vidro



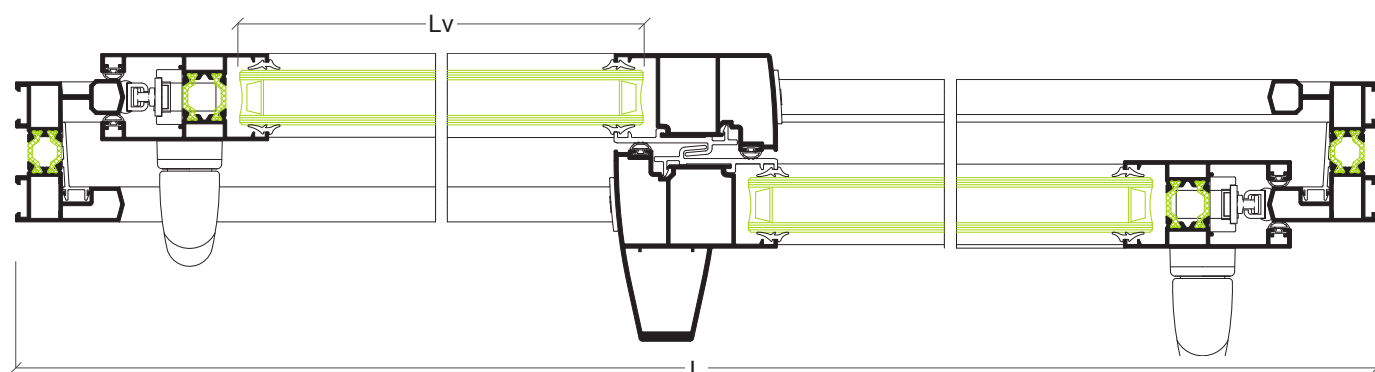



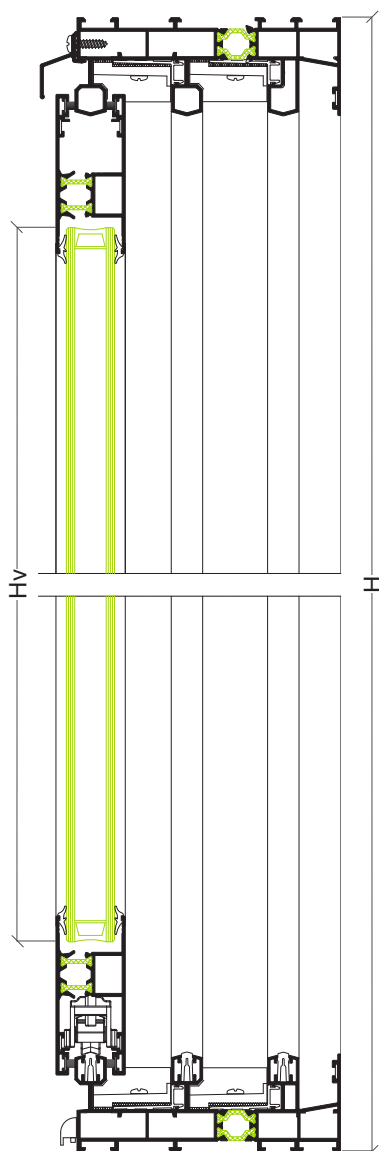
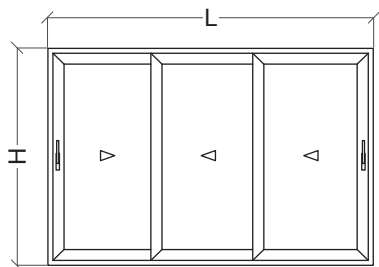





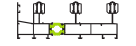

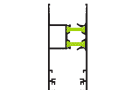

Hv = H-192 mm	Lv = L/2-119 mm
---------------	-----------------



Porta 3 folhas correr tri-rail



Perfis

Desenho	Ref	Descrição	Corte	Quant	Medida
	CT-51	Aro fixo perimetral		1	L
				2	H
	CT-52	Aro fixo perimetral		1	L
	CT-23	Tampa aro fixo		4	L-40 mm
				4	H-40 mm
	CT-53	Aro móvel perimetral		6	L/3+22.5 mm
				6	H-73 mm
	CT-54	Tampa cruzamento móvel		4	H-73 mm
	CT-29	Pingadeira superior		1	L
	CT-08	Cruzamento móvel		4	H-73 mm
	CT-71	Guia carril (poliamida)		3	L-93 mm

Acessórios e Juntas

Referência	Descrição	Quantidade
30 91 41 74	Esquadro aro fixo	12
30 91 40 25	Esquadro aro móvel	12
30 91 41 49	Rolamento duplo reforçado	6
----	Ferragem multiponto (600 ou 1800 mm)	2
30 91 41 47	Cremona multiponto	2
30 91 41 20	Calço nº 1 para multiponto	8 ou 16
30 91 41 71	Limitador de abertura	2
30 91 40 50	Guia lateral	4
30 91 41 70	Corta-ventos inferior/superior	6
30 91 41 00	Tampa guia recta	8
30 92 01 02	Goteiras	4
30 96 00 23	Esquadro alinhamento	24
----	Junta vidro	4L+12H
30 95 00 40'	Pelúcia 7x5.5 mm	4L+8H

* junta alternativa ref.: 30 91 41 88

Vidro

Hv = H-200 mm	Lv = L/3-104 mm
---------------	-----------------

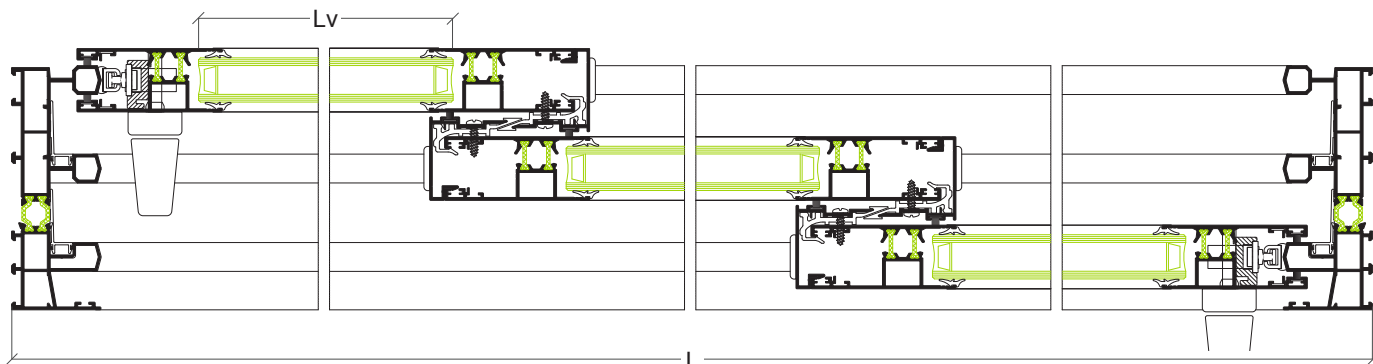

Janela 3 folhas correr tri-rail

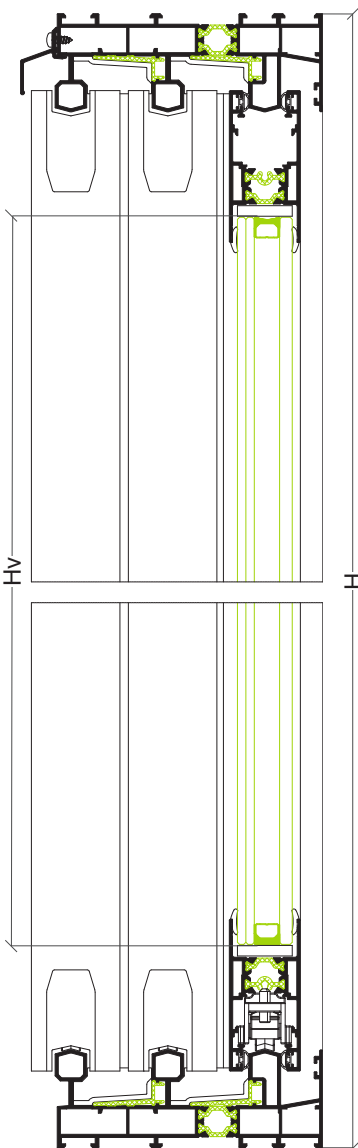
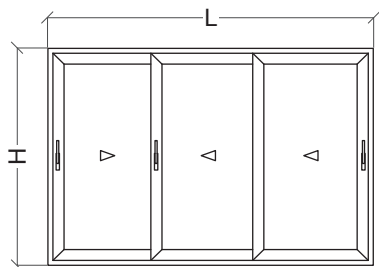

Perfis

Desenho	Ref	Descrição	Corte	Quant	Medida
	CT-51	Aro fixo perimetral		2	L
				2	H
	CT-23	Tampa aro fixo		4	L-40 mm
				4	H-40 mm
	CT-34	Aro móvel carrinho		6	L/3-64 mm
	CT-35	Aro móvel lateral		2	H-73 mm
	CT-36	Aro móvel central		4	H-73 mm
	CT-25	Cruzamento móvel		4	H-73 mm
	CT-29	Pingadeira superior		1	L

Acessórios e Juntas

Referência	Descrição	Quantidade
30 91 41 74	Esquadro aro fixo	12
30 91 40 35	Rolamento simples	6
30 91 40 42	Fecho lateral	2
30 91 41 69	Jogo cortaventos superior/inferior	2
30 91 41 81	Kit topos janela folhas laterais	2
30 91 41 83	Kit topos janela folhas centrais	1
30 92 01 00	Goteiras	2
30 91 41 88 *	Junta de correr	4L+8H

* pelúcia alternativa ref.: 30 95 00 40

Vidro

Hv = H-193 mm	Lv = L/3-76 mm
---------------	----------------

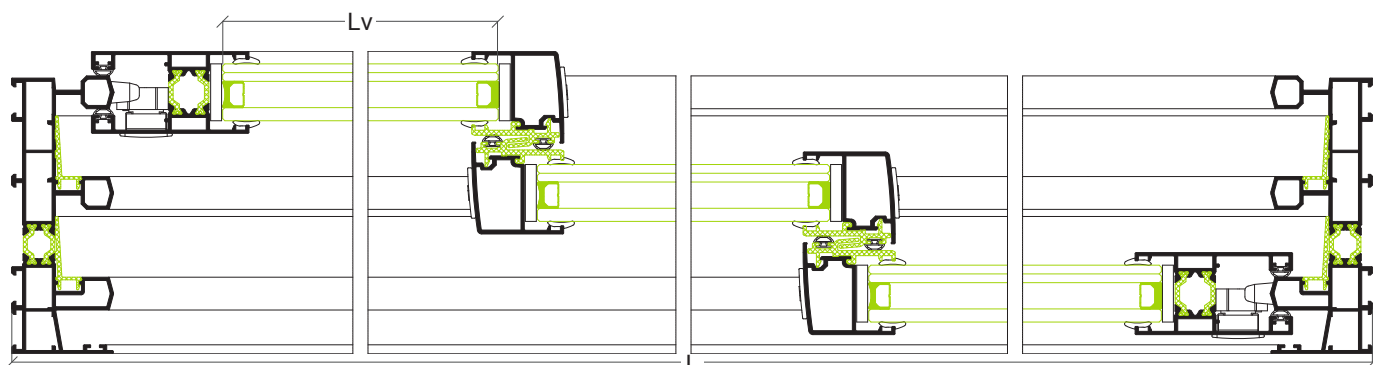

Janela 4 folhas correr

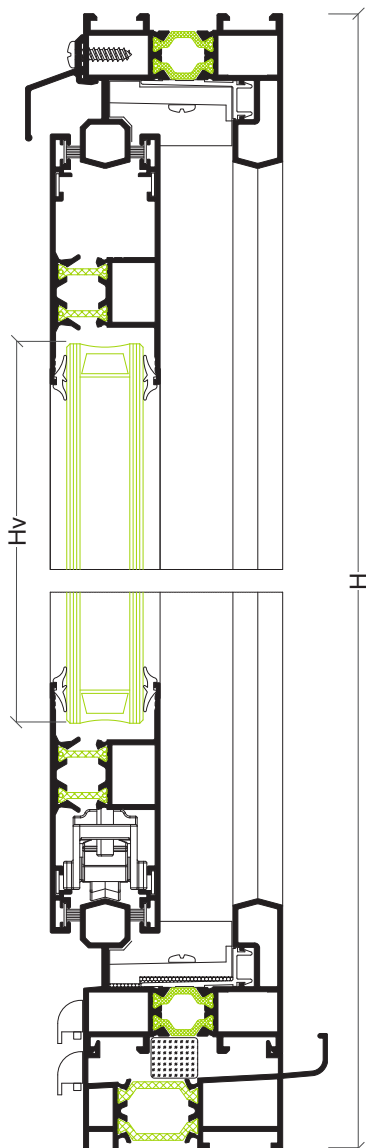
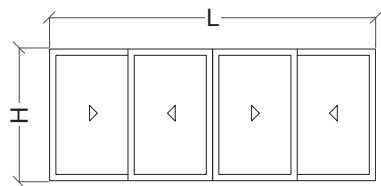

Perfis

Desenho	Ref	Descrição	Corte	Quant	Medida
	CT-41	Aro fixo perimetral		2	L
				2	H-28.5 mm
	CT-23	Tampa aro fixo		4	L-40 mm
				4	H-68 mm
	CT-53	Aro móvel perimetral		8	L/4+16.5 mm
				8	H-101.5 mm
	CT-54	Tampa cruzamento 2 folhas		4	H-101.5 mm
	CT-29	Pingadeira superior		1	L
	CT-08	Cruzamento móvel		4	H-101.5 mm
	CT-11	Soleira de condensação		1	L
	CT-24	União 3/4 folhas		1	L-101.5 mm

Acessórios e Juntas

Referência	Descrição	Quantidade
30 91 41 74	Esquadro aro fixo	8
30 91 40 25	Esquadro aro móvel	16
30 91 40 35	Rolamento simples	8
30 91 40 42	Fecho lateral	3
30 91 40 50	Guia lateral	6
30 91 41 70	Corta-ventos inferior/superior	3
30 91 41 00	Tampa móvel recta	8
30 92 01 02	Goteiras	4
30 96 00 12	Jogo topos condensação	1
30 96 00 23	Esquadro alinhamento	32
30 91 41 10	Taco anti-levantamento	3
30 92 04 70	Espuma isolante	L
----	Junta vidro	4L+16H
30 95 00 40'	Pelúcia 7x5.5 mm	4L+10H

* junta alternativa ref.: 30 91 41 88

Vidro

Hv = H-200 mm	Lv = L/4-110 mm
---------------	-----------------

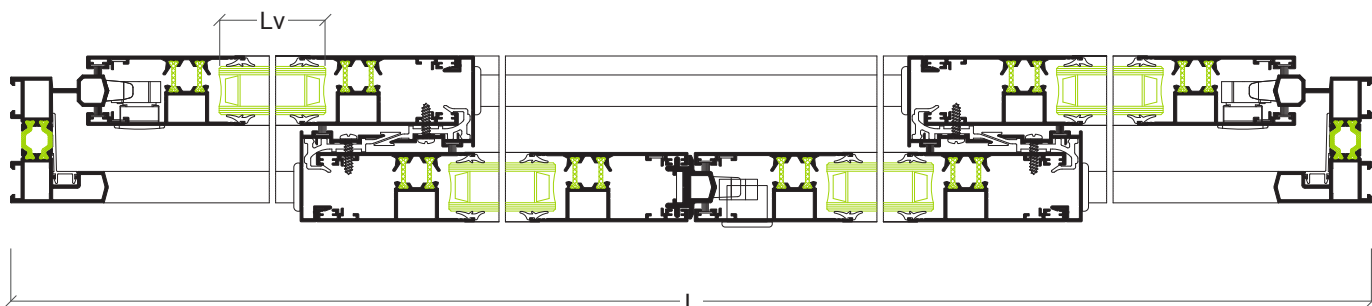

Porta 2 folhas correr multiponto

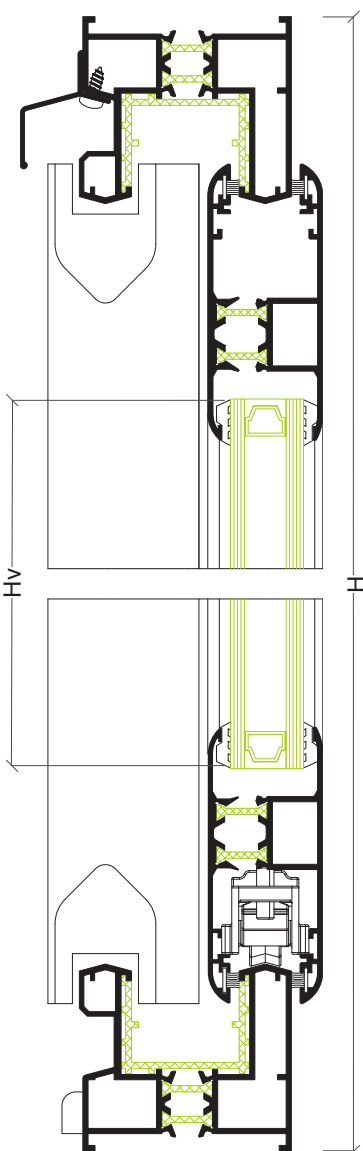
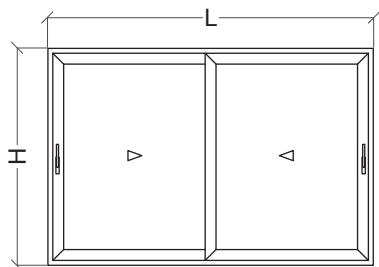

Perfis

Desenho	Ref	Descrição	Corte	Quant	Medida
	CT-01	Aro fixo perimetral		2	L
				2	H
	CT-09	Tampa aro fixo		2	L-45 mm
				2	H-45 mm
	CT-12	Aro móvel perimetral		4	L/2-4 mm
				4	H-85 mm
	CT-06	Tampa cruzamento móvel		2	H-85 mm
	CT-07	Pingadeira superior		1	L
	CT-08	Cruzamento móvel		2	H-85 mm
	CT-03	Reforço (opcional)		2	H-170 mm
	AX-19	Vareta (opcional)		2	H-170 mm

Acessórios e Juntas

Referência	Descrição	Quantidade
30 91 40 15	Esquadro aro fixo	8
30 91 40 25	Esquadro aro móvel	8
30 91 40 36	Rolamento duplo	4
30 91 40 50	Guia lateral	2
30 91 40 70	Corta-ventos inferior/superior	2
30 91 41 05	Jogo topos laterais	2
30 91 41 35	Jogo topos CT-03	2
30 92 01 02	Goteiras	2
30 96 00 23	Esquadro alinhamento	16
-----	Barra de ferragem multi-ponto (600 ou 1800 mm)	2
30 91 41 47	Cremona multiponto	2
30 91 41 20	Calço nº 1	8 ou 16
30 95 00 40*	Pelúcia 7x5.5 mm	2L+6H
-----	Junta vidro	4L+8H

* junta alternativa ref.: 30 91 41 88

Vidro

Hv = H-214 mm	Lv = (L/2)-133 mm
---------------	-------------------

